



BRAGA
ILLUMINAZIONE

Ovally

2



2163/S105-2 + 2163/S140-2 + 2163/S190-2 + AL.150-24 + AL.150-24 + AL.200-24 + 2129/R3

BRAGA LED

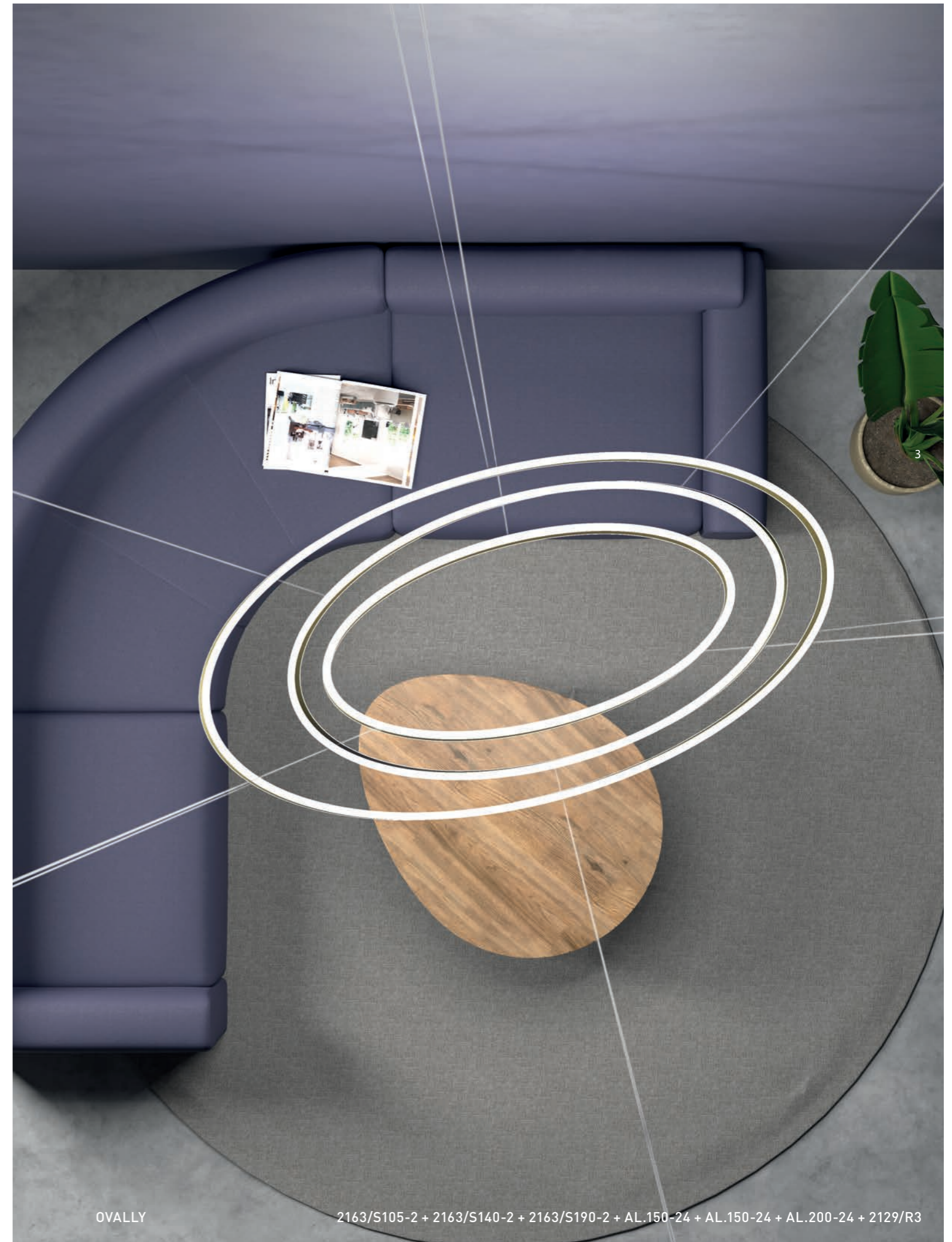

3

OVALLY

2163/S105-2 + 2163/S140-2 + 2163/S190-2 + AL.150-24 + AL.150-24 + AL.200-24 + 2129/R3

OVALLY

CRI > 80

DIMMERABILE / DIMMABLE

Vai a pagina / Go to page 58

DIFFUSORE / DIFFUSER

Silicone opalino
Opaline-finish Silicone

*** ROSONE / CANOPY**

Informazioni Tecniche vai a pag. 57
Technical info go to page 57

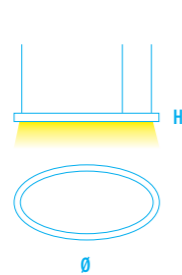

2163/S105-1

W 53 - Vdc 24

Lm 3.180

M 2.700°K - C 3.000°K

W 4.000°K

H 40 mm

L CAVI / CABLES 1.700 mm

L 1060 x 500 mm

+

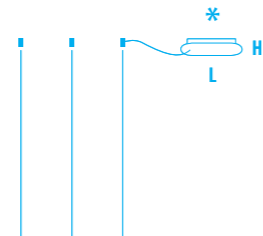

2129/R1-60

W 60 - Vac 230

H 45 mm

L 360x145 mm

DIMMERABILE / DIMMABLE

2129/R1-60 - D4

Taglio di fase / Phase Cut

2129/R1-60 - D6

1-10V - DALI - PUSH

2129/R1-60 - D7

ZigBee

2129/R1-60 - D8

CASAMBI

O/OR

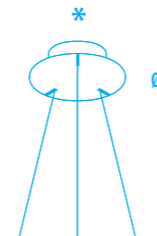

2129/R220-60

W 60 - Vac 230

H 45 mm

Ø 280 mm + Ø 220 mm

DIMMERABILE / DIMMABLE

2129/R220-60 - D4

Taglio di fase / Phase Cut

2129/R220-60 - D6

1-10V - DALI - PUSH

2129/R220-60 - D7

ZigBee

2129/R220-60 - D8

CASAMBI

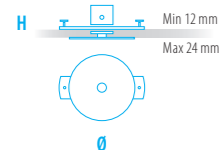

Rosone da incasso
Recessed canopy
Max 3,2 Kg

2146/R35

Ø 45 mm

H 35 mm

Ø 35 mm

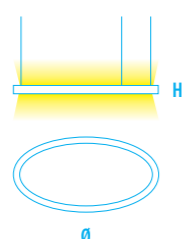

2163/S105-2

W 106 - Vdc 24

Lm 6.360

M 2.700°K - C 3.000°K

W 4.000°K

H 40 mm

L CAVI / CABLES 1.700 mm

L 1060 x 500 mm

+

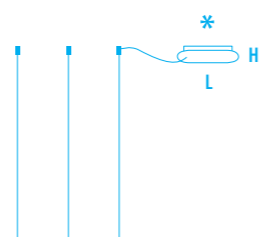

2129/R1-150

W 150 - Vac 230

H 45 mm

L 360x145 mm

DIMMERABILE / DIMMABLE

2129/R1-150 - D4

Taglio di fase / Phase Cut

2129/R1-150 - D6

1-10V - DALI - PUSH

2129/R1-150 - D7

ZigBee

2129/R1-150 - D8

CASAMBI

O/OR

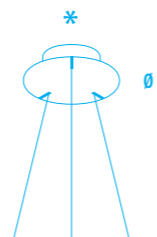

2129/R260-150

W 150 - Vac 230

H 45 mm

Ø 320 mm + Ø 260 mm

DIMMERABILE / DIMMABLE

2129/R260-150 - D4

Taglio di fase / Phase Cut

2129/R260-150 - D6

1-10V - DALI - PUSH

2129/R260-150 - D7

ZigBee

2129/R260-150 - D8

CASAMBI

10 Bianco White	13 Foglia Argento Silver Leaf	14 Foglia Oro Gold Leaf	15 Grigio Grey	19 Nero Black	21 Grigio tortora Dove grey	22 Foglia rame Copper leaf	23 Ruggine Rust	
24 Ferro Iron	28 Oro Gold	29 Alluminio Spaz. Brushed Alum.	30 Gunmetal	31 Rosé Spaz. Brushed Rosé	32 Bronzo Spaz. Brush. Bronze	33 Oro Spaz. Brush. Gold	34 Rosé Verniciato Painted Rosé	35 Bronzo Verniciato Bronze Painted

BICOLORE / TWO-TONE

Vai a pagina / Go to page 56

19 Nero Black	24 Ferro Iron	10 Bianco White
14 Foglia Oro Gold Leaf	13 Foglia Argento Silver Leaf	22 Foglia rame Copper leaf



OVALLY

2163/S140-2 + 2129/R1-150

OVALLY

CRI > 80

DIMMERABILE / DIMMABLE
Vai a pagina / Go to page 58

DIFFUSORE / DIFFUSER
Silicone opalino
Opaline-finish Silicone

* **ROSONE / CANOPY**
Informazioni Tecniche vai a pag. 57
Technical info go to page 57

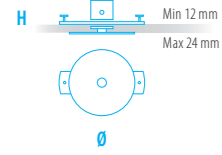

6

Rosone da incasso
Recessed canopy
Max 3,2 Kg

2146/R35

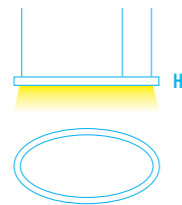

2163/S140-1

W 73 - Vdc 24
Lm 4.380
M 2.700°K - C 3.000°K
W 4.000°K
H 40 mm
L CAVI / CABLES 1.700 mm
L 1400 x 730 mm

+

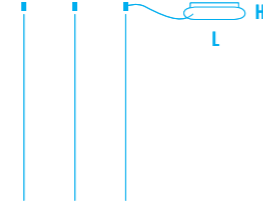

2129/R1-100

W 100 - Vac 230
H 45 mm
L 360 x 145 mm

O/OR

DIMMERABILE / DIMMABLE

2129/R1-100 - D4
Taglio di fase / Phase Cut
2129/R1-100 - D6
1-10V - DALI - PUSH
2129/R1-100 - D7
ZigBee
2129/R1-100 - D8
CASAMBI

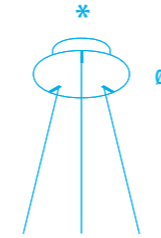

2129/R220-100

W 100 - Vac 230
H 45 mm
Ø 280 mm + Ø 220 mm

DIMMERABILE / DIMMABLE

2129/R220-100 - D4
Taglio di fase / Phase Cut
2129/R220-100 - D6
1-10V - DALI - PUSH
2129/R220-100 - D7
ZigBee
2129/R220-100 - D8
CASAMBI

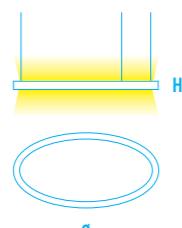

2163/S140-2

W 146 - Vdc 24
Lm 8.760
M 2.700°K - C 3.000°K
W 4.000°K
H 40 mm
L CAVI / CABLES 1.700 mm
L 1400 x 730 mm

+

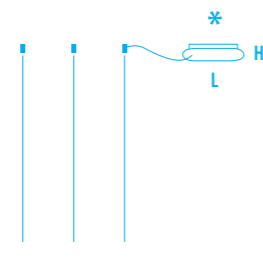

2129/R1-150

W 150 - Vac 230
H 45 mm
L 360 x 145 mm

O/OR

DIMMERABILE / DIMMABLE

2129/R1-150 - D4
Taglio di fase / Phase Cut
2129/R1-150 - D6
1-10V - DALI - PUSH
2129/R1-150 - D7
ZigBee
2129/R1-150 - D8
CASAMBI

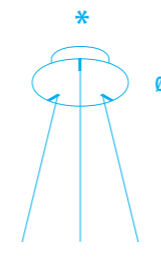

2129/R260-150

W 150 - Vac 230
H 45 mm
Ø 320 mm + Ø 260 mm

DIMMERABILE / DIMMABLE

2129/R260-150 - D4
Taglio di fase / Phase Cut
2129/R260-150 - D6
1-10V - DALI - PUSH
2129/R260-150 - D7
ZigBee
2129/R260-150 - D8
CASAMBI

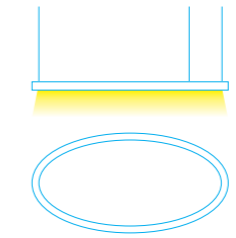

2163/S190-1

W 97 - Vdc 24
Lm 5.820
M 2.700°K - C 3.000°K
W 4.000°K
H 40 mm
L CAVI / CABLES 1.700 mm
L 1900 x 930 mm

+

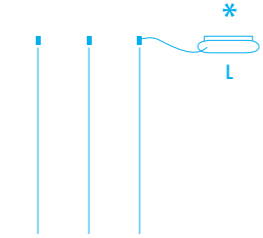

2129/R1-100

W 100 - Vac 230
H 45 mm
L 360 x 145 mm

O/OR

DIMMERABILE / DIMMABLE

2129/R1-100 - D4
Taglio di fase / Phase Cut
2129/R1-100 - D6
1-10V - DALI - PUSH
2129/R1-100 - D7
ZigBee
2129/R1-100 - D8
CASAMBI

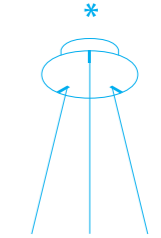

2129/R220-100

W 100 - Vac 230
H 45 mm
Ø 280 mm + Ø 220 mm

DIMMERABILE / DIMMABLE

2129/R220-100 - D4
Taglio di fase / Phase Cut
2129/R220-100 - D6
1-10V - DALI - PUSH
2129/R220-100 - D7
ZigBee
2129/R220-100 - D8
CASAMBI

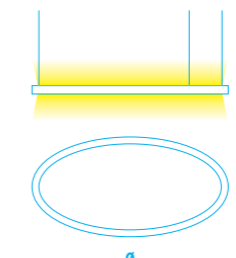

2163/S190-2

W 194 - Vdc 24
Lm 11.640
M 2.700°K - C 3.000°K
W 4.000°K
H 40 mm
L CAVI / CABLES 1.700 mm
L 1900 x 930 mm

+

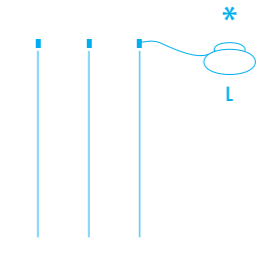

2129/R0-200

W 200 - Vac 230
H 45 mm
L 320 x 260 mm

O/OR

DIMMERABILE / DIMMABLE

2129/R0-200 - D4
Taglio di fase / Phase Cut
2129/R0-200 - D6
1-10V - DALI - PUSH
2129/R0-200 - D7
ZigBee
2129/R0-200 - D8
CASAMBI

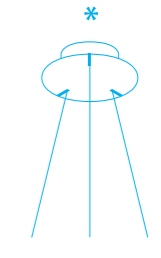

2129/R260-200

W 200 - Vac 230
H 45 mm
Ø 320 mm + Ø 260 mm

DIMMERABILE / DIMMABLE

2129/R260-200 - D4
Taglio di fase / Phase Cut
2129/R260-200 - D6
1-10V - DALI - PUSH
2129/R260-200 - D7
ZigBee
2129/R260-200 - D8
CASAMBI



BICOLORE / TWO-TONE

Vai a pagina / Go to page 56



OVALLY

CRI > 80

DIMMERABILE / DIMMABLE
Vai a pagina / Go to page 58

DIFFUSORE / DIFFUSER
Silicone opalino
Opaline-finish Silicone

* **ROSONE / CANOPY**
Informazioni Tecniche vai a pag. 57
Technical info go to page 57

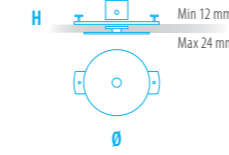

Rosone da incasso
Recessed canopy
Max 3,2 Kg

2146/R35

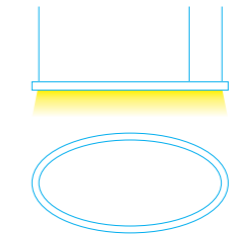

2163/S190-1

W 97 - Vdc 24
Lm 5.820
M 2.700°K - C 3.000°K
W 4.000°K
H 40 mm
L CAVI / CABLES 1.700 mm
L 1900 x 930 mm

+

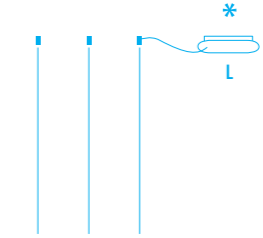

2129/R1-100

W 100 - Vac 230
H 45 mm
L 360 x 145 mm

O/OR

DIMMERABILE / DIMMABLE

2129/R1-100 - D4
Taglio di fase / Phase Cut
2129/R1-100 - D6
1-10V - DALI - PUSH
2129/R1-100 - D7
ZigBee
2129/R1-100 - D8
CASAMBI

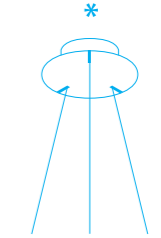

2129/R220-100

W 100 - Vac 230
H 45 mm
Ø 280 mm + Ø 220 mm

DIMMERABILE / DIMMABLE

2129/R220-100 - D4
Taglio di fase / Phase Cut
2129/R220-100 - D6
1-10V - DALI - PUSH
2129/R220-100 - D7
ZigBee
2129/R220-100 - D8
CASAMBI

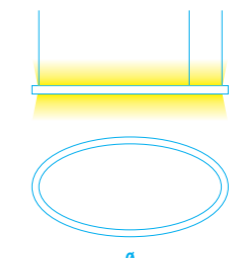

2163/S190-2

W 194 - Vdc 24
Lm 11.640
M 2.700°K - C 3.000°K
W 4.000°K
H 40 mm
L CAVI / CABLES 1.700 mm
L 1900 x 930 mm

+

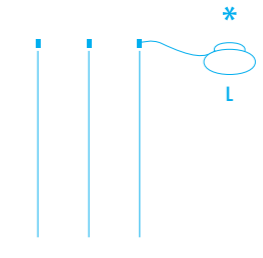

2129/R0-200

W 200 - Vac 230
H 45 mm
L 320 x 260 mm

O/OR

DIMMERABILE / DIMMABLE

2129/R0-200 - D4
Taglio di fase / Phase Cut
2129/R0-200 - D6
1-10V - DALI - PUSH
2129/R0-200 - D7
ZigBee
2129/R0-200 - D8
CASAMBI

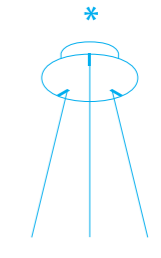

2129/R260-200

W 200 - Vac 230
H 45 mm
Ø 320 mm + Ø 260 mm

DIMMERABILE / DIMMABLE

2129/R260-200 - D4
Taglio di fase / Phase Cut
2129/R260-200 - D6
1-10V - DALI - PUSH
2129/R260-200 - D7
ZigBee
2129/R260-200 - D8
CASAMBI



BICOLORE / TWO-TONE

Vai a pagina / Go to page 56



7



OVALLY

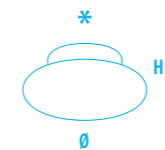
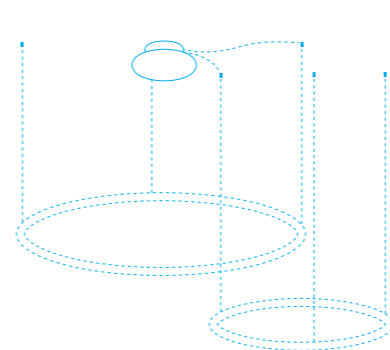

2129/R2
Rosone decentrato per
2 lampade /
Decentralized canopy
for 2 lamps

H 50 mm
Ø 410 mm + Ø 350 mm

ESEMPIO D'ORDINE / EXAMPLE OF ORDER

- N.1 2163/S105-1 C10
- N.1 2163/S190-2 C10
- N.1 2129/R2-10
- N.1 AL 60-24
- N.1 AL 200-24

ON/OFF

- AL 60-24 (S105-1)
- AL 100-24 (S140-1 / S190-1)
- AL 150-24 (S105-2 / S140-2)
- AL 200-24 (S190-2)

DIMMERABILE / DIMMABLE D4 (TAGLIO DI FASE/PHASE CUT)

- AL 75-24-D4 (S105-1 / S140-1)
- AL 100-24-D4 (S190-1)
- AL 150-24-D4 (S105-2 / S140-2)
- AL 200-24-D4 (S190-2)

DIMMERABILE / DIMMABLE D6 (1-10V-DALI-PUSH)

- AL 60-24-D6 (S105-1)
- AL 100-24-D6 (S140-1 / S190-1)
- AL 150-24-D6 (S105-2 / S140-2)
- AL 200-24-D6 (S190-2)

DIMMERABILE / DIMMABLE D7 (ZIGBEE)

- AL 60-24-D7 (S105-1)
- AL 100-24-D7 (S140-1 / S190-1)
- AL 150-24-D7 (S105-2 / S140-2)
- AL 200-24-D7 (S190-2)

DIMMERABILE / DIMMABLE D8 (CASAMBI)

- AL 60-24-D8 (S105-1)
- AL 100-24-D8 (S140-1 / S190-1)
- AL 150-24-D8 (S105-2 / S140-2)
- AL 200-24-D8 (S190-2)

* ROSONE / CANOPY

Informazioni Tecniche vai a pag. 57
Technical info go to page 57

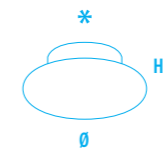
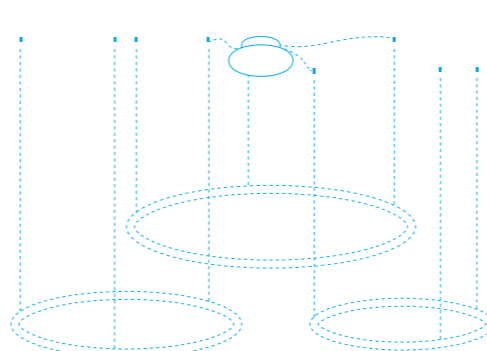

2129/R3
Rosone decentrato
per 3 lampade /
Decentralized canopy
for 3 lamps

H 50 mm
Ø 500 mm + Ø 440 mm

ESEMPIO D'ORDINE / EXAMPLE OF ORDER

- N.1 2163/S105-1 C19
- N.1 2163/S140-1 C19
- N.1 2163/S190-2 C19
- N.1 2129/R3-19
- N.1 AL 75-24 - D4
- N.1 AL 75-24 - D4
- N.1 AL 200-24 - D4

10 Bianco White	13 Foglia Argento Silver Leaf	14 Foglia Oro Gold Leaf	15 Grigio Grey	19 Nero Black	21 Grigio tortora Dove grey	22 Foglia rame Copper leaf	23 Ruggine Rust	
24 Ferro Iron	28 Oro Gold	29 Alluminio Spaz. Brushed Alum.	30 Gunmetal	31 Rosé Spaz. Brushed Rosé	32 Bronzo Spaz. Brush. Bronze	33 Oro Spaz. Brush. Gold	34 Rosé Verniciato Painted Rosé	35 Bronzo Verniciato Bronze Painted

OVALLY

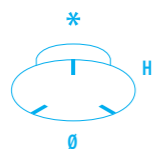
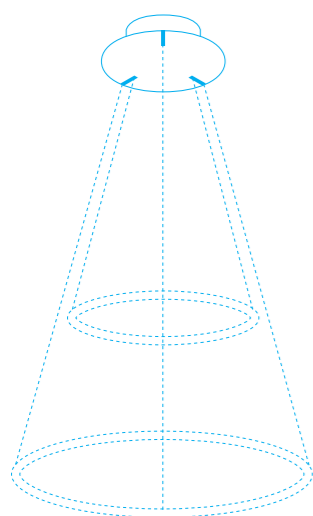

2129/R350
Rosone centrale per 2 lampade /
Central canopy for 2 lamps

H 50 mm
Ø 410 mm + Ø 350 mm

ON/OFF

- AL 60-24 (S105-1)
- AL 100-24 (S140-1 / S190-1)
- AL 150-24 (S105-2 / S140-2)
- AL 200-24 (S190-2)

DIMMERABILE / DIMMABLE D4 (TAGLIO DI FASE/PHASE CUT)

- AL 75-24-D4 (S105-1 / S140-1)
- AL 100-24-D4 (S190-1)
- AL 150-24-D4 (S105-2 / S140-2)
- AL 200-24-D4 (S190-2)

DIMMERABILE / DIMMABLE D6 (1-10V-DALI-PUSH)

- AL 60-24-D6 (S105-1)
- AL 100-24-D6 (S140-1 / S190-1)
- AL 150-24-D6 (S105-2 / S140-2)
- AL 200-24-D6 (S190-2)

DIMMERABILE / DIMMABLE D7 (ZIGBEE)

- AL 60-24-D7 (S105-1)
- AL 100-24-D7 (S140-1 / S190-1)
- AL 150-24-D7 (S105-2 / S140-2)
- AL 200-24-D7 (S190-2)

DIMMERABILE / DIMMABLE D8 (CASAMBI)

- AL 60-24-D8 (S105-1)
- AL 100-24-D8 (S140-1 / S190-1)
- AL 150-24-D8 (S105-2 / S140-2)
- AL 200-24-D8 (S190-2)

*** ROSONE / CANOPY**

Informazioni Tecniche vai a pag. 57
Technical info go to page 57

10 **ESEMPIO D'ORDINE / EXAMPLE OF ORDER**

- N.1 2163/S105-1 C10
- N.1 2163/S140-2 C10
- N.1 2129/R350 - 10
- N.1 AL 60-24
- N.1 AL 150-24

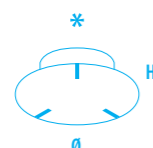
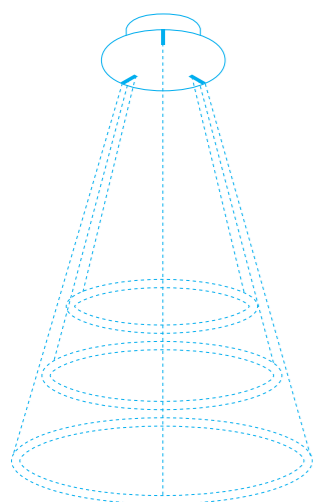

2129/R440
Rosone centrale per 3 lampade /
Central canopy for 3 lamps

H 50 mm
Ø 500 mm + Ø 440 mm

ESEMPIO D'ORDINE / EXAMPLE OF ORDER

- N.1 2163/S105-1 C19
- N.1 2163/S140-1 C19
- N.1 2163/S190-2 C19
- N.1 2129/R440-19
- N.1 AL 75-24 - D4
- N.1 AL 75-24 - D4
- N.1 AL 200-24 - D4

10 Bianco White	13 Foglia Argento Silver Leaf	14 Foglia Oro Gold Leaf	15 Grigio Grey	19 Nero Black	21 Grigio tortora Dove grey	22 Foglia rame Copper leaf	23 Ruggine Rust	
24 Ferro Iron	28 Oro Gold	29 Alluminio Spaz. Brushed Alum.	30 Gunmetal	31 Rosè Spaz. Brushed Rosè	32 Bronzo Spaz. Brush. Bronze	33 Oro Spaz. Brush. Gold	34 Rosè Verniciato Painted Rosè	35 Bronzo Verniciato Bronze Painted



OVALLY

CRI > 80

DIMMERABILE / DIMMABLE

Vai a pagina / Go to page 58

DIFFUSORE / DIFFUSER

Silicone opalino
Opaline-finish Silicone

*** ROSONE / CANOPY**

Informazioni Tecniche vai a pag. 57
Technical info go to page 57

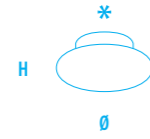

2133/R

Rosone con Alimentatore 75W
Base whit Power Supply 75W

H 30 mm
Ø 220 mm + Ø 190 mm

DIMMERABILE / DIMMABLE

2133/R - D4
Taglio di fase / Phase Cut

2133/R - D6
1-10V - DALI - PUSH

2133/R - D8
CASAMBI

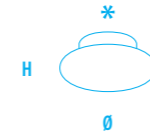

2129/R220-0-150

Rosone con Alimentatore 150W
Base whit Power Supply 150W

H 45 mm
Ø 280 mm + Ø 220 mm

DIMMERABILE / DIMMABLE

2129/R220-0-150 - D4
Taglio di fase / Phase Cut

2129/R220-0-150 - D6
1-10V - DALI - PUSH

2129/R220-0-150 - D8
CASAMBI

12

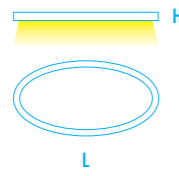

2163/TR105

W 53 - Vdc 24

Lm 3.180
M 2.700°K
C 3.000°K - W 4.000°K

H 40 mm
L 1060 x 500 mm

ALIMENTATORE REMOTO
REMOTE POWER SUPPLY

ON/OFF
AL.60-24

DIMMERABILE / DIMMABLE

AL.75-24 - D4
Taglio di fase / Phase Cut

AL.60-24 - D6
1-10V - DALI - PUSH

AL.60-24 - D7
ZigBee

AL.60-24 - D8
CASAMBI

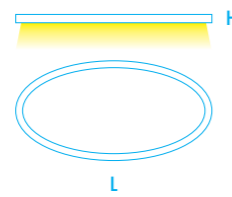

2163/TR140

W 73 - Vdc 24

Lm 4.380
M 2.700°K
C 3.000°K - W 4.000°K

H 40 mm
L 1400 x 730 mm

ALIMENTATORE REMOTO
REMOTE POWER SUPPLY

ON/OFF
AL.100-24

DIMMERABILE / DIMMABLE

AL.75-24 - D4
Taglio di fase / Phase Cut

AL.100-24 - D6
1-10V - DALI - PUSH

AL.100-24 - D7
ZigBee

AL.100-24 - D8
CASAMBI

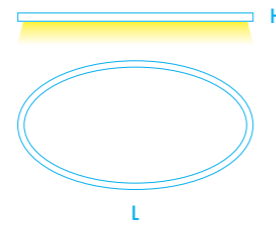

2163/TR190

W 97 - Vdc 24

Lm 5.820
M 2.700°K
C 3.000°K - W 4.000°K

H 40 mm
L 1900 x 930 mm

ALIMENTATORE REMOTO
REMOTE POWER SUPPLY

ON/OFF
AL.100-24

DIMMERABILE / DIMMABLE

AL.100-24 - D4
Taglio di fase / Phase Cut

AL.100-24 - D6
1-10V - DALI - PUSH

AL.100-24 - D7
ZigBee

AL.100-24 - D8
CASAMBI



BICOLORE / TWO-TONE

Vai a pagina / Go to page 56



13



OVALLY

2163/TR105 + AL.60-24

Figure

14



2161/PL60 + 2161/PL75 + 2162/PL50 + 2162/PL60 + 2162/PL75

BRAGA LED

15



FIGURE



2161/PL40 + PL50 + PL60 + PL75

BRAGA LED

FIGURE

CRI > 80

DIMMERABILE / DIMMABLE

Vai a pagina / Go to page 58

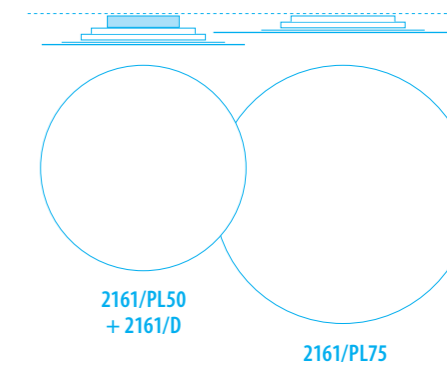
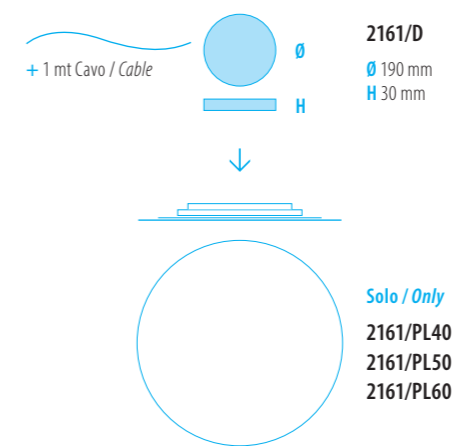

2161/PL40

W 21 - Vac 230

Lm 2.800
M 2.700°K
C 3.000°K - W 4.000°K

H 55 mm
Ø 400 mm

DIMMERABILE / DIMMABLE

2161/PL40 - D4

Taglio di fase / Phase Cut

2161/PL40 - D6
1-10V - DALI - PUSH

2161/PL40 - D7
ZigBee

2161/PL40 - D8
CASAMBI

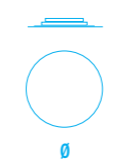

2161/PL50

W 26 - Vac 230

Lm 2.800
M 2.700°K
C 3.000°K - W 4.000°K

H 55 mm
Ø 500 mm

DIMMERABILE / DIMMABLE

2161/PL50 - D4

Taglio di fase / Phase Cut

2161/PL50 - D6
1-10V - DALI - PUSH

2161/PL50 - D7
ZigBee

2161/PL50 - D8
CASAMBI

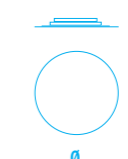

2161/PL60

W 26 - Vac 230

Lm 3.400
M 2.700°K
C 3.000°K - W 4.000°K

H 55 mm
Ø 600 mm

DIMMERABILE / DIMMABLE

2161/PL60 - D4

Taglio di fase / Phase Cut

2161/PL60 - D6
1-10V - DALI - PUSH

2161/PL60 - D7
ZigBee

2161/PL60 - D8
CASAMBI

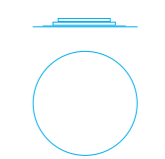

2161/PL75

W 42 - Vac 230

Lm 5.600
M 2.700°K
C 3.000°K - W 4.000°K

H 55 mm
Ø 750 mm

DIMMERABILE / DIMMABLE

2161/PL75 - D4

Taglio di fase / Phase Cut

2161/PL75 - D6
1-10V - DALI - PUSH

2161/PL75 - D7
ZigBee

2161/PL75 - D8
CASAMBI

10 Bianco White	13 Foglia Argento Silver Leaf	14 Foglia Oro Gold Leaf	19 Nero Black	22 Foglia rame Copper leaf	23 Ruggine Rust	
24 Ferro Iron	27 Ossidato Oxydized	29 Alluminio Spaz. Brushed Alum.	30 Gunmetal	31 Rosé Spaz. Brushed Rosé	32 Bronzo Spaz. Brush. Bronze	33 Oro Spaz. Brush. Gold

SPECCHIO / MIRROR
Solo/Only PL50

90
Specchio
Mirror





FIGURE

CRI > 80

DIMMERABILE / DIMMABLE

Vai a pagina / Go to page 58

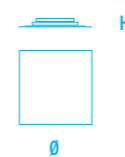
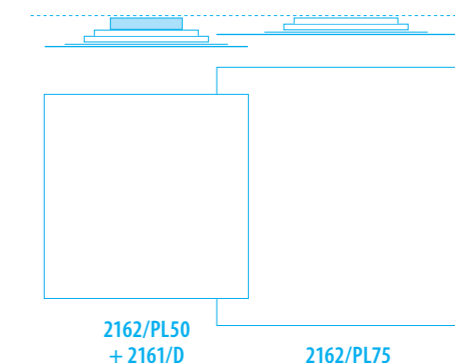
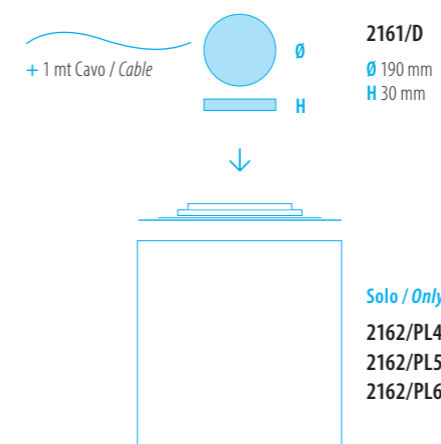

2162/PL40

W 21 - Vac 230

Lm 2.800
M 2.700°K
C 3.000°K - W 4.000°K

H 55 mm
Ø 400 mm

DIMMERABILE / DIMMABLE

2162/PL40 - D4

Taglio di fase / Phase Cut

2162/PL40 - D6
1-10V - DALI - PUSH

2162/PL40 - D7
ZigBee

2162/PL40 - D8
CASAMBI



2162/PL50

W 21 - Vac 230

Lm 2.800
M 2.700°K
C 3.000°K - W 4.000°K

H 55 mm
Ø 500 mm

DIMMERABILE / DIMMABLE

2162/PL50 - D4

Taglio di fase / Phase Cut

2162/PL50 - D6
1-10V - DALI - PUSH

2162/PL50 - D7
ZigBee

2162/PL50 - D8
CASAMBI

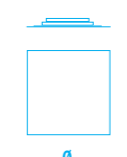

2162/PL60

W 26 - Vac 230

Lm 3.400
M 2.700°K
C 3.000°K - W 4.000°K

H 55 mm
Ø 600 mm

DIMMERABILE / DIMMABLE

2162/PL60 - D4

Taglio di fase / Phase Cut

2162/PL60 - D6
1-10V - DALI - PUSH

2162/PL60 - D7
ZigBee

2162/PL60 - D8
CASAMBI

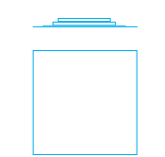

2162/PL75

W 42 - Vac 230

Lm 5.600
M 2.700°K
C 3.000°K - W 4.000°K

H 55 mm
Ø 750 mm

DIMMERABILE / DIMMABLE

2162/PL75 - D4

Taglio di fase / Phase Cut

2162/PL75 - D6
1-10V - DALI - PUSH

2162/PL75 - D7
ZigBee

2162/PL75 - D8
CASAMBI

10 Bianco White	13 Foglia Argento Silver Leaf	14 Foglia Oro Gold Leaf	19 Nero Black	22 Foglia rame Copper leaf	23 Ruggine Rust	
24 Ferro Iron	27 Ossidato Oxydized	29 Alluminio Spaz. Brushed Alum.	30 Gunmetal	31 Rosé Spaz. Brushed Rosé	32 Bronzo Spaz. Brush. Bronze	33 Oro Spaz. Brush. Gold

SPECCHIO / MIRROR
Solo/Only PL50



FIGURE

CRI > 80

DIMMERABILE / DIMMABLE

Vai a pagina / Go to page 58



2161/PL50

W 21 - Vac 230

Lm 2.800
M 2.700°K
C 3.000°K - W 4.000°K

H 55 mm
Ø 500 mm

DIMMERABILE / DIMMABLE

2161/PL50 - D4

Taglio di fase / Phase Cut

2161/PL50 - D6
1-10V - DALI - PUSH

2161/PL50 - D7
ZigBee

2161/PL50 - D8
CASAMBI

SPECCHIO / MIRROR

Solo / Only 50 cm

90

Specchio
Mirror

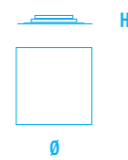

2162/PL50

W 21 - Vac 230

Lm 2.800
M 2.700°K
C 3.000°K - W 4.000°K

H 55 mm
Ø 500 mm

DIMMERABILE / DIMMABLE

2162/PL50 - D4

Taglio di fase / Phase Cut

2162/PL50 - D6
1-10V - DALI - PUSH

2162/PL50 - D7
ZigBee

2162/PL50 - D8
CASAMBI



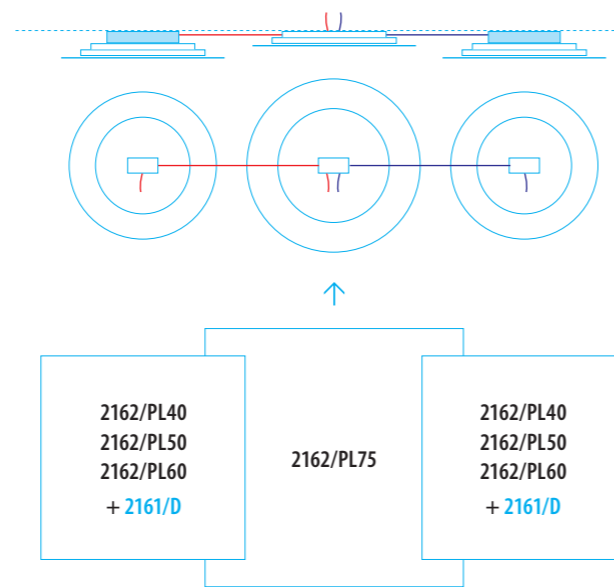
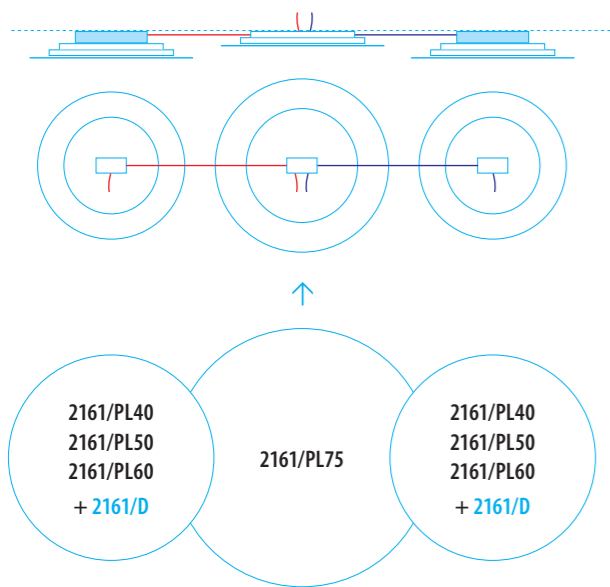

LA VERSIONE BIANCA ALL'OCCORRENZA PUÒ ESSERE DIPINTA O VERNICIATA. CONSIGLIAMO DI APPLICARE UN FONDO PRIMER PRIMA DELLA PERSONALIZZAZIONE.

—

IF NECESSARY THE WHITE VERSION COULD BE PAINTED. WE SUGGEST TO APPLY A PRIMER BEFORE CUSTOMIZATION.

FIGURE

Inside

24



2165/CD245

BRAGA LED

25

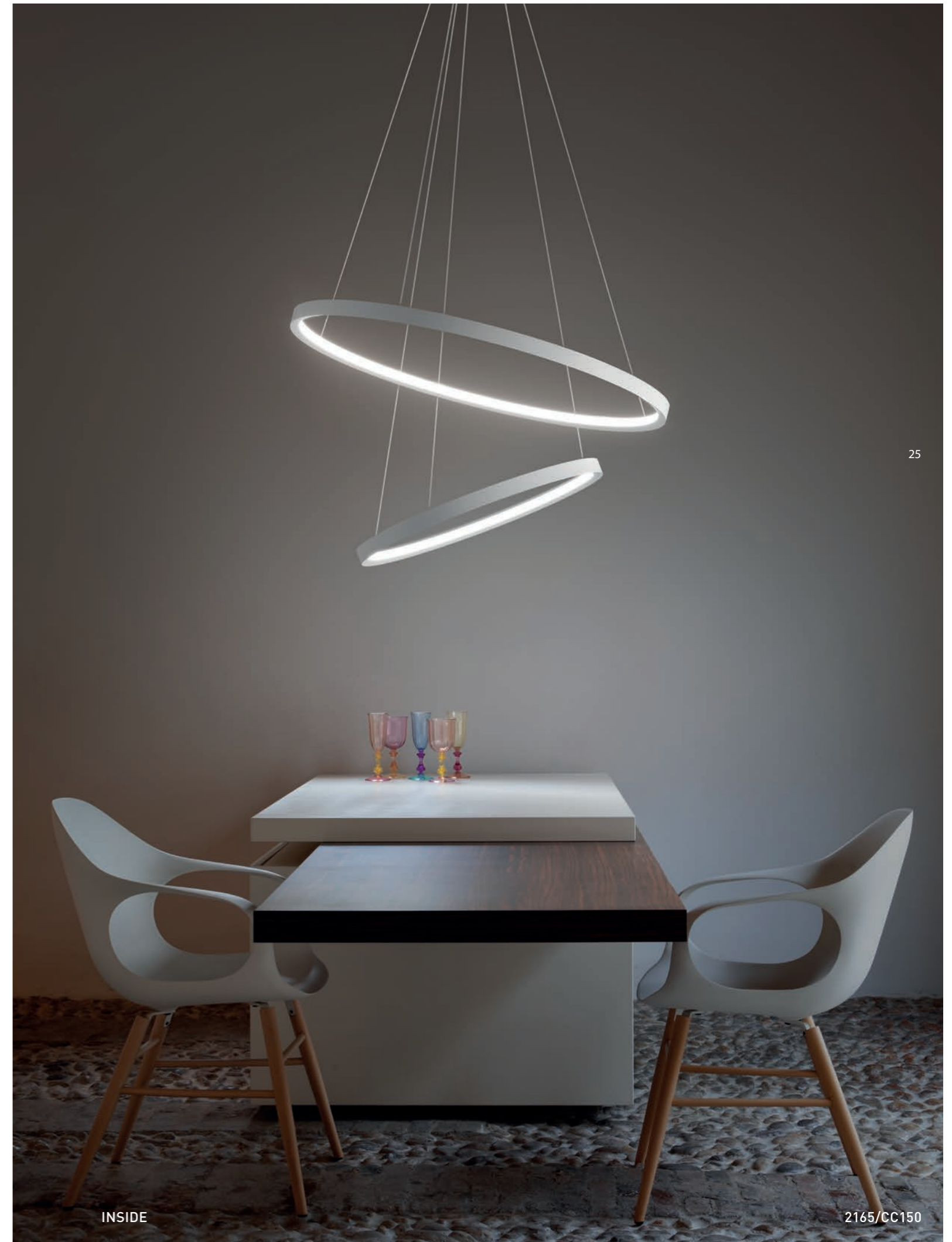

INSIDE

2165/CC150

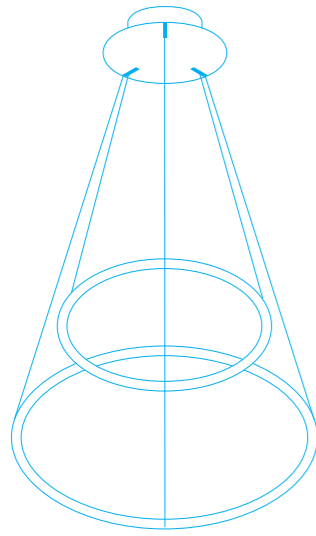

2165/CC125
W 81 - **Vac** 230
Lm 5.700
M 2.700°K - **C** 3.000°K
W 4.000°K
H 35 mm
L CAVI / CABLES 4.000 mm
Ø 500 mm + **Ø** 750 mm
ROSONE / CANOPY
H 45 mm
Ø 320 mm + **Ø** 260 mm
DIMMERABILE / DIMMABLE
2165/CC125 - D4
 Taglio di fase / Phase Cut
2165/CC125 - D6
 1-10V - DALI - PUSH
2165/CC125 - D7
 ZigBee
2165/CC125 - D8
 CASAMBI

2165/CC150
W 98 - **Vac** 230
Lm 7.000
M 2.700°K - **C** 3.000°K
W 4.000°K
H 35 mm
L CAVI / CABLES 4.000 mm
Ø 600 mm + **Ø** 900 mm
ROSONE / CANOPY
H 45 mm
Ø 320 mm + **Ø** 260 mm
DIMMERABILE / DIMMABLE
2165/CC150 - D4
 Taglio di fase / Phase Cut
2165/CC150 - D6
 1-10V - DALI - PUSH
2165/CC150 - D7
 ZigBee
2165/CC150 - D8
 CASAMBI

2165/CC190
W 123 - **Vac** 230
Lm 8.800
M 2.700°K - **C** 3.000°K
W 4.000°K
H 35 mm
L CAVI / CABLES 4.000 mm
Ø 400 mm + **Ø** 600 mm + **Ø** 900 mm
ROSONE / CANOPY
H 50 mm
Ø 410 mm + **Ø** 350 mm
DIMMERABILE / DIMMABLE
2165/CC190 - D4
 Taglio di fase / Phase Cut
2165/CC190 - D6
 1-10V - DALI - PUSH
2165/CC190 - D7
 ZigBee
2165/CC190 - D8
 CASAMBI

2165/CC245
W 160 - **Vac** 230
Lm 11.400
M 2.700°K - **C** 3.000°K
W 4.000°K
H 35 mm
L CAVI / CABLES 4.000 mm
Ø 500 mm + **Ø** 750 mm + **Ø** 1200 mm
ROSONE / CANOPY
H 50 mm
Ø 410 mm + **Ø** 350 mm
DIMMERABILE / DIMMABLE
2165/CC245 - D4
 Taglio di fase / Phase Cut
2165/CC245 - D6
 1-10V - DALI - PUSH
2165/CC245 - D7
 ZigBee
2165/CC245 - D8
 CASAMBI

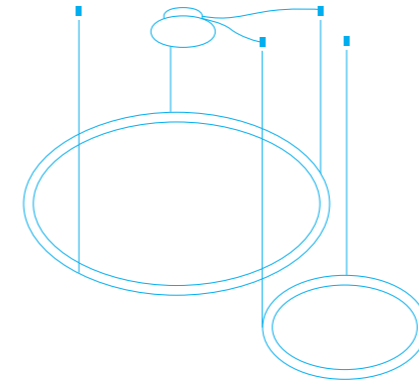

2165/CD125
W 81 - **Vac** 230
Lm 5.700
M 2.700°K - **C** 3.000°K
W 4.000°K
H 35 mm
L CAVI / CABLES 4.000 mm
Ø 500 mm + **Ø** 750 mm
ROSONE / CANOPY
H 45 mm
Ø 320 mm + **Ø** 260 mm
DIMMERABILE / DIMMABLE
2165/CD125 - D4
 Taglio di fase / Phase Cut
2165/CD125 - D6
 1-10V - DALI - PUSH
2165/CD125 - D7
 ZigBee
2165/CD125 - D8
 CASAMBI

2165/CD150
W 98 - **Vac** 230
Lm 7.000
M 2.700°K - **C** 3.000°K
W 4.000°K
H 35 mm
L CAVI / CABLES 4.000 mm
Ø 600 mm + **Ø** 900 mm
ROSONE / CANOPY
H 45 mm
Ø 320 mm + **Ø** 260 mm
DIMMERABILE / DIMMABLE
2165/CD150 - D4
 Taglio di fase / Phase Cut
2165/CD150 - D6
 1-10V - DALI - PUSH
2165/CD150 - D7
 ZigBee
2165/CD150 - D8
 CASAMBI

2165/CD190
W 123 - **Vac** 230
Lm 8.800
M 2.700°K - **C** 3.000°K
W 4.000°K
H 35 mm
L CAVI / CABLES 4.000 mm
Ø 400 mm + **Ø** 600 mm + **Ø** 900 mm
ROSONE / CANOPY
H 45 mm
Ø 320 mm + **Ø** 260 mm
DIMMERABILE / DIMMABLE
2165/CD190 - D4
 Taglio di fase / Phase Cut
2165/CD190 - D6
 1-10V - DALI - PUSH
2165/CD190 - D7
 ZigBee
2165/CD190 - D8
 CASAMBI

2165/CD245
W 160 - **Vac** 230
Lm 11.400
M 2.700°K - **C** 3.000°K
W 4.000°K
H 35 mm
L CAVI / CABLES 4.000 mm
Ø 500 mm + **Ø** 750 mm + **Ø** 1200 mm
ROSONE / CANOPY
H 45 mm
Ø 320 mm + **Ø** 260 mm
DIMMERABILE / DIMMABLE
2165/CD245 - D4
 Taglio di fase / Phase Cut
2165/CD245 - D6
 1-10V - DALI - PUSH
2165/CD245 - D7
 ZigBee
2165/CD245 - D8
 CASAMBI



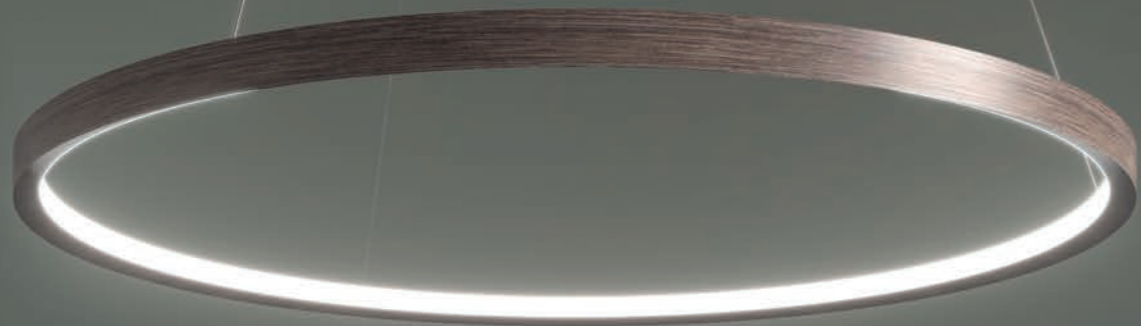

INSIDE

CRI > 80

DIMMERABILE / DIMMABLE

Vai a pagina / Go to page 58

DIFFUSORE / DIFFUSER

Silicone opalino
Opaline-finish Silicone

*** ROSONE / CANOPY**

Informazioni Tecniche vai a pag. 57
Technical info go to page 57

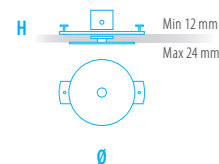

30 Rosone da incasso
Recessed canopy
Max 3,2 Kg

2146/R35

Ø 45 mm
H 35 mm
Ø 35 mm

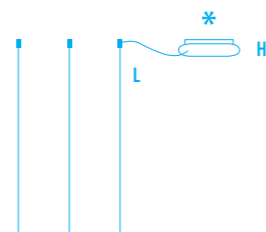

2129/R1-30

W 30 - Vac 230
H 45 mm
L 360x145 mm

DIMMERABILE / DIMMABLE

2129/R1-30 - D4

Taglio di fase / Phase Cut

2129/R1-30 - D6

1-10V - DALI - PUSH

2129/R1-30 - D7

ZigBee

2129/R1-30 - D8

CASAMBI

O/OR

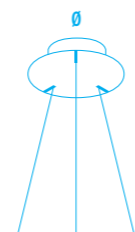

2129/R220-30

W 30 - Vac 230
H 45 mm
Ø 280 mm + Ø 220 mm

DIMMERABILE / DIMMABLE

2129/R220-30 - D4

Taglio di fase / Phase Cut

2129/R220-30 - D6

1-10V - DALI - PUSH

2129/R220-30 - D7

ZigBee

2129/R220-30 - D8

CASAMBI

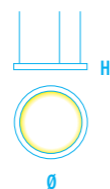

2165/S40

W 25 - Vdc 24

Lm 1.800

M 2.700°K - C 3.000°K

W 4.000°K

H 35 mm

L CAVI / CABLES 1.700 mm

Ø 400 mm

INSIDE

CRI > 80

DIMMERABILE / DIMMABLE

Vai a pagina / Go to page 58

DIFFUSORE / DIFFUSER

Silicone opalino
Opaline-finish Silicone

*** ROSONE / CANOPY**

Informazioni Tecniche vai a pag. 57
Technical info go to page 57

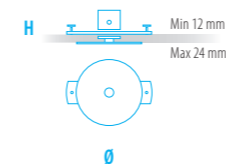

Rosone da incasso
Recessed canopy
Max 3,2 Kg

2146/R35

Ø 45 mm
H 35 mm
Ø 35 mm

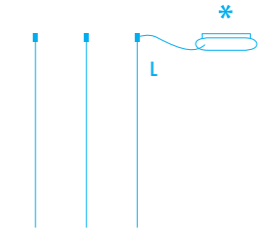

2165/S50

W 60 - Vac 230
H 45 mm
L 360x145 mm

DIMMERABILE / DIMMABLE

2129/R1-60 - D4

Taglio di fase / Phase Cut

2129/R1-60 - D6

1-10V - DALI - PUSH

2129/R1-60 - D7

ZigBee

2129/R1-60 - D8

CASAMBI

O/OR

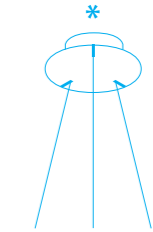

2129/R220-60

W 60 - Vac 230
H 45 mm
Ø 280 mm + Ø 220 mm

DIMMERABILE / DIMMABLE

2129/R220-60 - D4

Taglio di fase / Phase Cut

2129/R220-60 - D6

1-10V - DALI - PUSH

2129/R220-60 - D7

ZigBee

2129/R220-60 - D8

CASAMBI

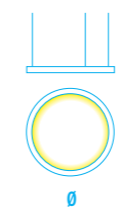

2165/S50

W 32 - Vdc 24

Lm 2.300

M 2.700°K - C 3.000°K

W 4.000°K

H 35 mm

L CAVI / CABLES 1.700 mm

Ø 500 mm

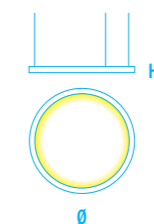

2165/S60

W 38 - Vdc 24

Lm 2.750

M 2.700°K - C 3.000°K

W 4.000°K

H 35 mm

L CAVI / CABLES 1.700 mm

Ø 600 mm

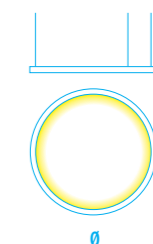

2175/S75

W 49 - Vdc 24

Lm 3.550

M 2.700°K - C 3.000°K

W 4.000°K

H 35 mm

L CAVI / CABLES 1.700 mm

Ø 750 mm



INSIDE

CRI > 80

DIMMERABILE / DIMMABLE

Vai a pagina / Go to page 58

DIFFUSORE / DIFFUSER

Silicone opalino
Opaline-finish Silicone

*** ROSONE / CANOPY**

Informazioni Tecniche vai a pag. 57
Technical info go to page 57

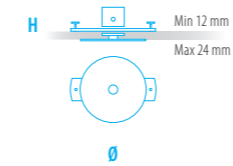

Rosone da incasso
Recessed canopy
Max 3,2 Kg

2146/R35

Ø 45 mm
H 35 mm
Ø 35 mm

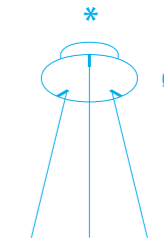
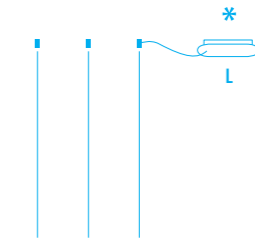

2165/S90
2165/S120

+

2129/R1-100
W 100 - Vac 230
H 45 mm
L 360x145 mm

DIMMERABILE / DIMMABLE

2129/R1-100 - D4

Taglio di fase / Phase Cut

2129/R1-100 - D6

1-10V - DALI - PUSH

2129/R1-100 - D7

ZigBee

2129/R1-100 - D8

CASAMBI

O/OR

2129/R220-100
W 100 - Vac 230

H 45 mm
Ø 280 mm + Ø 220 mm

DIMMERABILE / DIMMABLE

2129/R220-100 - D4

Taglio di fase / Phase Cut

2129/R220-100 - D6

1-10V - DALI - PUSH

2129/R220-100 - D7

ZigBee

2129/R220-100 - D8

CASAMBI

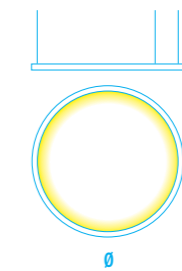

2165/S90

W 60 - Vdc 24
Lm 4.300
M 2.700°K - C 3.000°K
W 4.000°K
H 35 mm
L CAVI / CABLES 1.700 mm
Ø 900 mm

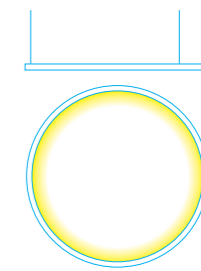

2165/S120

W 79 - Vdc 24
Lm 5.700
M 2.700°K - C 3.000°K
W 4.000°K
H 35 mm
L CAVI / CABLES 1.700 mm
Ø 1.200 mm



BRAGA LED

INSIDE

CRI > 80

DIMMERABILE / DIMMABLE

Vai a pagina / Go to page 58

DIFFUSORE / DIFFUSER

Silicone opalino
Opaline-finish Silicone

*** ROSONE / CANOPY**

Informazioni Tecniche vai a pag. 57
Technical info go to page 57

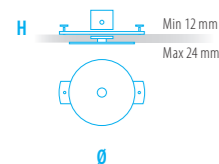

34 Rosone da incasso
Recessed canopy
Max 3,2 Kg

2146/R35

Ø 45 mm
H 35 mm
Ø 35 mm

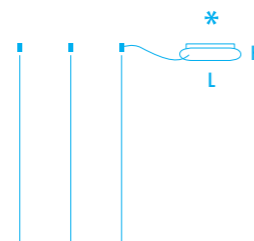

2129/R1-150

W 150 - Vac 230
H 45 mm
L 360x145 mm

DIMMERABILE / DIMMABLE

2129/R1-150 - D4

Taglio di fase / Phase Cut

2129/R1-150 - D6

1-10V - DALI - PUSH

2129/R1-150 - D7

ZigBee

2129/R1-150 - D8

CASAMBI

O/OR

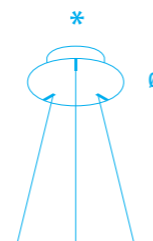

2129/R260-150

W 150 - Vac 230
H 45 mm
Ø 320 mm + Ø 260 mm

DIMMERABILE / DIMMABLE

2129/R260-150 - D4

Taglio di fase / Phase Cut

2129/R260-150 - D6

1-10V - DALI - PUSH

2129/R260-150 - D7

ZigBee

2129/R260-150 - D8

CASAMBI

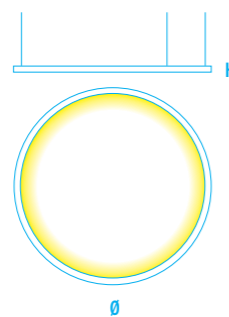

2165/S150

W 99 - Vdc 24

Lm 7.100

M 2.700°K - C 3.000°K

W 4.000°K

H 35 mm

L CAVI / CABLES 1.700 mm

Ø 1.500 mm

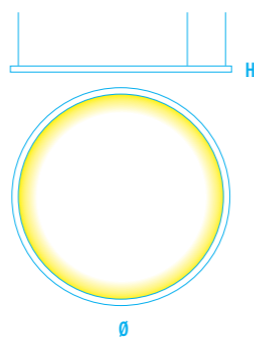

2165/S200

W 136 - Vdc 24

Lm 9.800

M 2.700°K - C 3.000°K

W 4.000°K

H 35 mm

L CAVI / CABLES 1.700 mm

Ø 2.000 mm

10 Bianco White	13 Foglia Argento Silver Leaf	14 Foglia Oro Gold Leaf	15 Grigio Grey	19 Nero Black	21 Grigio tortora Dove grey	22 Foglia rame Copper leaf	23 Ruggine Rust	
24 Ferro Iron	28 Oro Gold	29 Alluminio Spaz. Brushed Alum.	30 Gunmetal	31 Rosé Spaz. Brushed Rosé	32 Bronzo Spaz. Brush. Bronze	33 Oro Spaz. Brush. Gold	34 Rosé Verniciato Painted Rosé	35 Bronzo Verniciato Bronze Painted



INSIDE

2165/S90 + 2165/S120 + AL.100-24 + AL.150-24 + 2129/R2

INSIDE

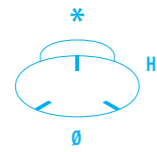
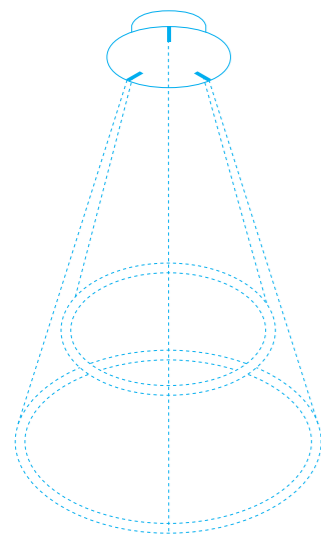

2129/R350
Rosone centrale per 2 lampade /
Central canopy for 2 lamps

H 50 mm
Ø 410 mm + Ø 350 mm

ON/OFF

- AL 30-24 (S40)
- AL 60-24 (S50 / S60 / S75)
- AL 100-24 (S90 / S120)
- AL 150-24 (S150 / S200)

DIMMERABILE / DIMMABLE D4 (TAGLIO DI FASE/PHASE CUT)

- AL 30-24-D4 (S40)
- AL 50-24-D4 (S50 / S60)
- AL 75-24-D4 (S75 / S90)
- AL 100-24-D4 (S120)
- AL 150-24-D4 (S150 / S200)

DIMMERABILE / DIMMABLE D6 (1-10V-DALI-PUSH)

- AL 30-24-D6 (S40)
- AL 60-24-D6 (S50 / S60 / S75)
- AL 100-24-D6 (S90 / S120)
- AL 150-24-D6 (S150 / S200)

DIMMERABILE / DIMMABLE D7 (ZIGBEE)

- AL 30-24-D7 (S40)
- AL 60-24-D7 (S50 / S60 / S75)
- AL 100-24-D7 (S90 / S120)
- AL 150-24-D7 (S150 / S200)

DIMMERABILE / DIMMABLE D8 (CASAMBI)

- AL 30-24-D8 (S40)
- AL 60-24-D8 (S50 / S60 / S75)
- AL 100-24-D8 (S90 / S120)
- AL 150-24-D8 (S150 / S200)

*** ROSONE / CANOPY**

Informazioni Tecniche vai a pag. 57
Technical info go to page 57

36 **ESEMPIO D'ORDINE / EXAMPLE OF ORDER**

- N.1 2165/S90 C10
- N.1 2165/S150 C10
- N.1 2129/R350 - 10
- N.1 AL 100-24
- N.1 AL 150-24

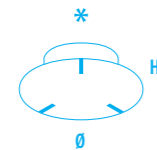
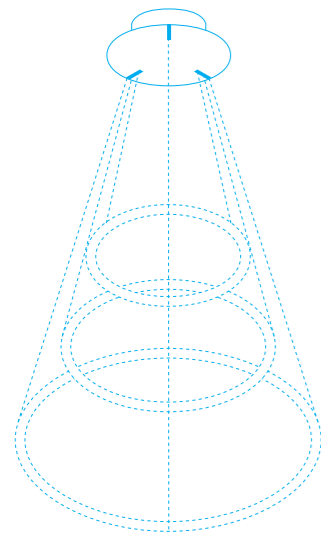

2129/R440
Rosone centrale per 3 lampade /
Central canopy for 3 lamps

H 50 mm
Ø 500 mm + Ø 440 mm

10 Bianco White	13 Foglia Argento Silver Leaf	14 Foglia Oro Gold Leaf	15 Grigio Grey	19 Nero Black	21 Grigio tortora Dove grey	22 Foglia rame Copper leaf	23 Ruggine Rust	
24 Ferro Iron	28 Oro Gold	29 Alluminio Spaz. Brushed Alum.	30 Gunmetal	31 Rosè Spaz. Brushed Rosè	32 Bronzo Spaz. Brush. Bronze	33 Oro Spaz. Brush. Gold	34 Rosè Verniciato Painted Rosè	35 Bronzo Verniciato Bronze Painted

ESEMPIO D'ORDINE / EXAMPLE OF ORDER

- N.1 2165/S90 C19
- N.1 2165/S120 C19
- N.1 2165/S150 C19
- N.1 2129/R440-19
- N.1 AL 75-24 - D4
- N.1 AL 100-24 - D4
- N.1 AL 150-24 - D4



INSIDE

2165/S60 + 2165/S90 + 2165/S200 + AL.100-24 + AL.100-24 + AL.150-24 + 2129/R440



INSIDE

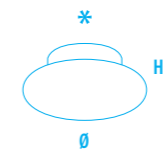
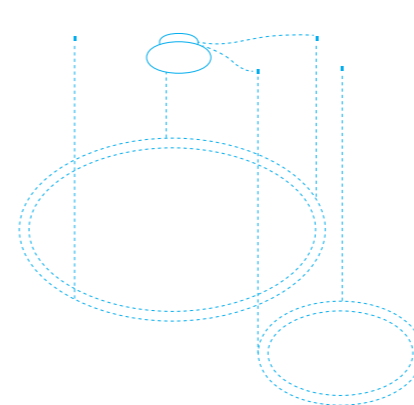

2129/R2
Rosone decentrato per
2 lampade /
Decentralized canopy
for 2 lamps

H 50 mm
Ø 410 mm + Ø 350 mm

ESEMPIO D'ORDINE / EXAMPLE OF ORDER

- N.1 2165/S90 C10
- N.1 2165/S120 C10
- N.1 2129/R2-10
- N.1 AL 100-24
- N.1 AL 150-24

ON/OFF

- AL 30-24 (S40)
- AL 60-24 (S50 / S60 / S75)
- AL 100-24 (S90 / S120)
- AL 150-24 (S150 / S200)

DIMMERABILE / DIMMABLE D4 (TAGLIO DI FASE/PHASE CUT)

- AL 30-24-D4 (S40)
- AL 50-24-D4 (S50 / S60)
- AL 75-24-D4 (S75 / S90)
- AL 100-24-D4 (S120)
- AL 150-24-D4 (S150 / S200)

DIMMERABILE / DIMMABLE D6 (1-10V-DALI-PUSH)

- AL 30-24-D6 (S40)
- AL 60-24-D6 (S50 / S60 / S75)
- AL 100-24-D6 (S90 / S120)
- AL 150-24-D6 (S150 / S200)

DIMMERABILE / DIMMABLE D7 (ZIGBEE)

- AL 30-24-D7 (S40)
- AL 60-24-D7 (S50 / S60 / S75)
- AL 100-24-D7 (S90 / S120)
- AL 150-24-D7 (S150 / S200)

DIMMERABILE / DIMMABLE D8 (CASAMBI)

- AL 30-24-D8 (S40)
- AL 60-24-D8 (S50 / S60 / S75)
- AL 100-24-D8 (S90 / S120)
- AL 150-24-D8 (S150 / S200)

* ROSONE / CANOPY

Informazioni Tecniche vai a pag. 57
Technical info go to page 57

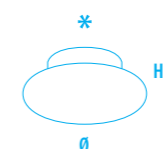
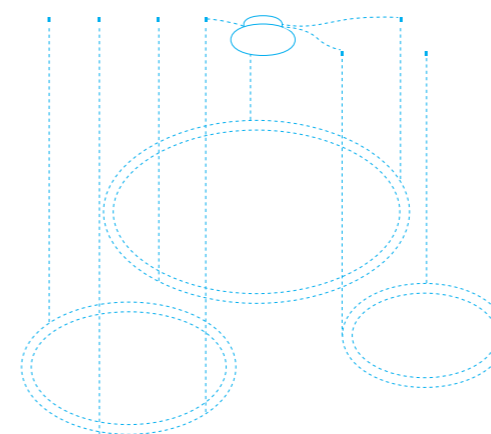

2129/R3
Rosone decentrato
per 3 lampade /
Decentralized canopy
for 3 lamps

H 50 mm
Ø 500 mm + Ø 440 mm

ESEMPIO D'ORDINE / EXAMPLE OF ORDER

- N.1 2165/S90 C19
- N.1 2165/S120 C19
- N.1 2165/S150 C19
- N.1 2129/R3-19
- N.1 AL 75-24 - D4
- N.1 AL 100-24 - D4
- N.1 AL 150-24 - D4

10 Bianco White	13 Foglia Argento Silver Leaf	14 Foglia Oro Gold Leaf	15 Grigio Grey	19 Nero Black	21 Grigio tortora Dove grey	22 Foglia rame Copper leaf	23 Ruggine Rust	
24 Ferro Iron	28 Oro Gold	29 Alluminio Spaz. Brushed Alum.	30 Gunmetal	31 Rosé Spaz. Brushed Rosé	32 Bronzo Spaz. Brush. Bronze	33 Oro Spaz. Brush. Gold	34 Rosé Verniciato Painted Rosé	35 Bronzo Verniciato Bronze Painted

Lumiluna

40



2166/CD245

BRAGA LED



41

LUMILUNA

2166/CC245

LUMILUNA

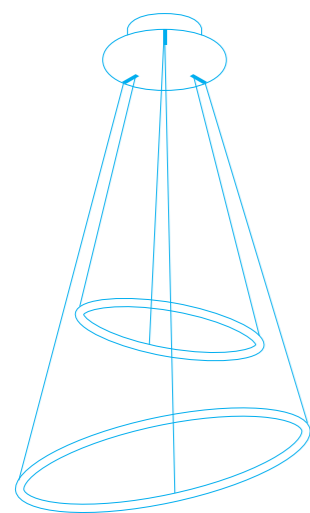

COMPOSIZIONE CENTRATA CENTERED COMPOSITION

2166/CC245

W 126 - Vac 230

Lm 9.000

M 2.700°K - C 3.000°K

W 4.000°K

H 35 mm

L CAVI / CABLES 4.000 mm

L 1060 x 500 mm + L 1400 x 730 mm

ROSONE / CANOPY

H 45 mm

Ø 320 mm + Ø 260 mm

DIMMERABILE / DIMMABLE

2166/CC245 - D4

Taglio di fase / Phase Cut

2166/CC245 - D6

1-10V - DALI - PUSH

2166/CC245 - D7

ZigBee

2166/CC245 - D8

CASAMBI

42

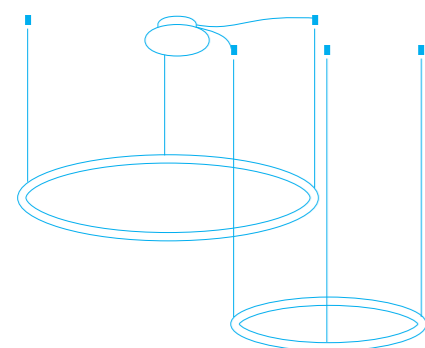

COMPOSIZIONE DECENTRATA DECENTRALIZED COMPOSITION

2166/CD245

W 126 - Vac 230

Lm 9.000

M 2.700°K - C 3.000°K

W 4.000°K

H 35 mm

L CAVI / CABLES 4.000 mm

L 1060 x 500 mm + L 1400 x 730 mm

ROSONE / CANOPY

H 45 mm

Ø 320 mm + Ø 260 mm

DIMMERABILE / DIMMABLE

2166/CD245 - D4

Taglio di fase / Phase Cut

2166/CD245 - D6

1-10V - DALI - PUSH

2166/CD245 - D7

ZigBee

2166/CD245 - D8

CASAMBI

10

Bianco
White



13

Foglia Argento
Silver Leaf



14

Foglia Oro
Gold Leaf



15

Grigio
Grey



19

Nero
Black



21

Grigio tortora
Dove grey



22

Foglia rame
Copper leaf



23

Ruggine
Rust



24

Ferro
Iron



28

Oro
Gold



29

Alluminio Spaz.
Brushed Alum.



30

Gunmetal



31

Rosè Spaz.
Brushed Rosè



32

Bronzo Spaz.
Brush. Bronze



33

Oro Spaz.
Brush. Gold



34

Rosè Verniciato
Painted Rosè



35

Bronzo Verniciato
Bronze Painted



43

LUMILUNA

2166/S105 + 2129/R220-60

LUMILUNA

CRI > 80

DIMMERABILE / DIMMABLE

Vai a pagina / Go to page 58

DIFFUSORE / DIFFUSER

Silicone opalino
Opaline-finish Silicone

*** ROSONE / CANOPY**

Informazioni Tecniche vai a pag. 57
Technical info go to page 57

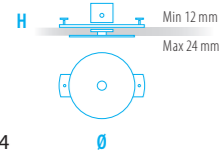

44

Rosone da incasso
Recessed canopy
Max 3,2 Kg

2146/R35

∅ 45 mm
H 35 mm
∅ 35 mm

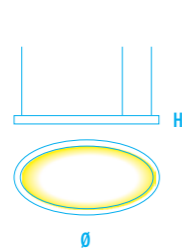

2166/S105

W 53 - Vdc 24
Lm 3.800
M 2.700°K - C 3.000°K
W 4.000°K
H 35 mm
L CAVI / CABLES 1.700 mm
L 1060 x 500 mm

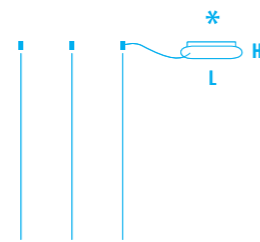

2129/R1-60

W 60 - Vac 230
H 45 mm
L 360 x 145 mm
DIMMERABILE / DIMMABLE
2129/R1-60 - D4
Taglio di fase / Phase Cut
2129/R1-60 - D6
1-10V - DALI - PUSH
2129/R1-60 - D7
ZigBee
2129/R1-60 - D8
CASAMBI

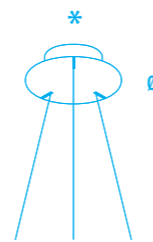

2129/R220-60

W 60 - Vac 230
H 45 mm
∅ 280 mm + ∅ 220 mm
DIMMERABILE / DIMMABLE
2129/R220-60 - D4
Taglio di fase / Phase Cut
2129/R220-60 - D6
1-10V - DALI - PUSH
2129/R220-60 - D7
ZigBee
2129/R220-60 - D8
CASAMBI



LUMILUNA

CRI > 80

DIMMERABILE / DIMMABLE

Vai a pagina / Go to page 58

DIFFUSORE / DIFFUSER

Silicone opalino
Opaline-finish Silicone

*** ROSONE / CANOPY**

Informazioni Tecniche vai a pag. 57
Technical info go to page 57

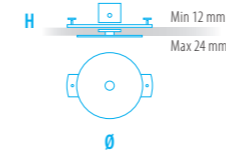

Rosone da incasso
Recessed canopy
Max 3,2 Kg

2146/R35

∅ 45 mm
H 35 mm
∅ 35 mm

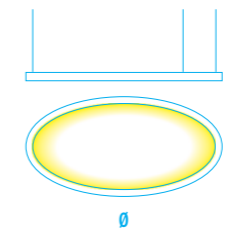

2166/S140

W 73 - Vdc 24
Lm 5.200
M 2.700°K - C 3.000°K
W 4.000°K
H 35 mm
L CAVI / CABLES 1.700 mm
L 1400 x 730 mm

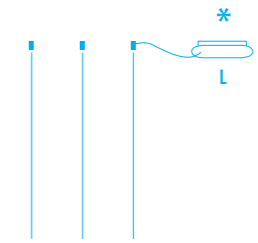

2129/R1-100

W 100 - Vac 230
H 45 mm
L 360 x 145 mm
DIMMERABILE / DIMMABLE
2129/R1-100 - D4
Taglio di fase / Phase Cut
2129/R1-100 - D6
1-10V - DALI - PUSH
2129/R1-100 - D7
ZigBee
2129/R1-100 - D8
CASAMBI

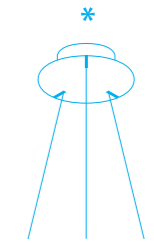

2129/R220-100

W 100 - Vac 230
H 45 mm
∅ 280 mm + ∅ 220 mm
DIMMERABILE / DIMMABLE
2129/R220-100 - D4
Taglio di fase / Phase Cut
2129/R220-100 - D6
1-10V - DALI - PUSH
2129/R220-100 - D7
ZigBee
2129/R220-100 - D8
CASAMBI

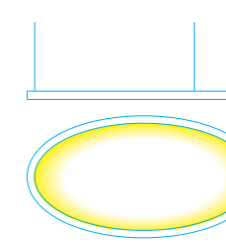

2166/S190

W 97 - Vdc 24
Lm 7.000
M 2.700°K - C 3.000°K
W 4.000°K
H 35 mm
L CAVI / CABLES 1.700 mm
L 1900 x 930 mm

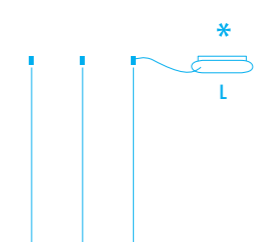

2129/R1-100

W 100 - Vac 230
H 45 mm
L 360 x 145 mm
DIMMERABILE / DIMMABLE
2129/R1-100 - D4
Taglio di fase / Phase Cut
2129/R1-100 - D6
1-10V - DALI - PUSH
2129/R1-100 - D7
ZigBee
2129/R1-100 - D8
CASAMBI

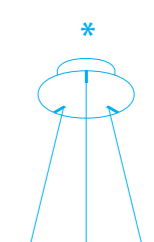

2129/R220-100

W 100 - Vac 230
H 45 mm
∅ 280 mm + ∅ 220 mm
DIMMERABILE / DIMMABLE
2129/R220-100 - D4
Taglio di fase / Phase Cut
2129/R220-100 - D6
1-10V - DALI - PUSH
2129/R220-100 - D7
ZigBee
2129/R220-100 - D8
CASAMBI





LUMILUNA

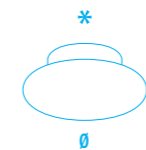
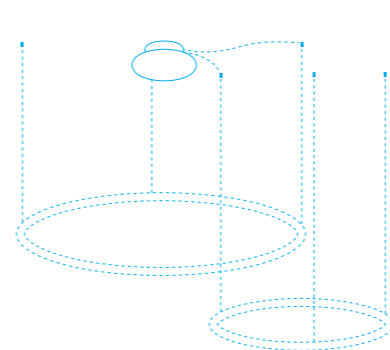

2129/R2
Rosone decentrato per
2 lampade /
Decentralized canopy
for 2 lamps

H 50 mm
Ø 410 mm + Ø 350 mm

ESEMPIO D'ORDINE / EXAMPLE OF ORDER

- N.1 2166/S105 C10
- N.1 2166/S140 C10
- N.1 2129/R2-10
- N.1 AL 60-24
- N.1 AL 100-24

ON/OFF

- AL 60-24 (S105)
- AL 100-24 (S140 / S190)

DIMMERABILE / DIMMABLE D4 (TAGLIO DI FASE/PHASE CUT)

- AL 75-24-D4 (S105 / S140)
- AL 100-24-D4 (S190)

DIMMERABILE / DIMMABLE D6 (1-10V-DALI-PUSH)

- AL 60-24-D6 (S105)
- AL 100-24-D6 (S140 / S190)

DIMMERABILE / DIMMABLE D7 (ZIGBEE)

- AL 60-24-D7 (S105)
- AL 100-24-D7 (S140 / S190)

DIMMERABILE / DIMMABLE D8 (CASAMBI)

- AL 60-24-D8 (S105)
- AL 100-24-D8 (S140 / S190)

* ROSONE / CANOPY

Informazioni Tecniche vai a pag. 57
Technical info go to page 57

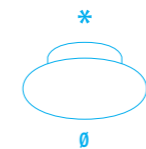
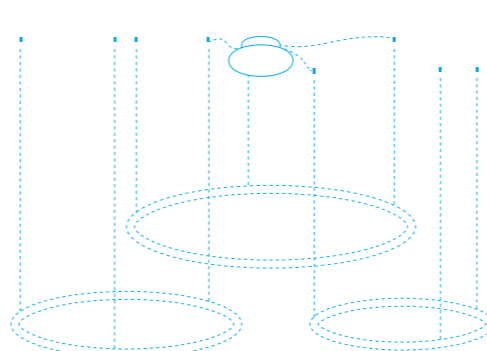

2129/R3
Rosone decentrato
per 3 lampade /
Decentralized canopy
for 3 lamps

H 50 mm
Ø 500 mm + Ø 440 mm

ESEMPIO D'ORDINE / EXAMPLE OF ORDER

- N.1 2166/S105 C19
- N.1 2166/S140 C19
- N.1 2166/S190 C19
- N.1 2129/R3-19
- N.1 AL 75-24 - D4
- N.1 AL 75-24 - D4
- N.1 AL 100-24 - D4

10 Bianco White	13 Foglia Argento Silver Leaf	14 Foglia Oro Gold Leaf	15 Grigio Grey	19 Nero Black	21 Grigio tortora Dove grey	22 Foglia rame Copper leaf	23 Ruggine Rust	
24 Ferro Iron	28 Oro Gold	29 Alluminio Spaz. Brushed Alum.	30 Gunmetal	31 Rosé Spaz. Brushed Rosé	32 Bronzo Spaz. Brush. Bronze	33 Oro Spaz. Brush. Gold	34 Rosé Verniciato Painted Rosé	35 Bronzo Verniciato Bronze Painted

LUMILUNA

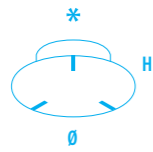
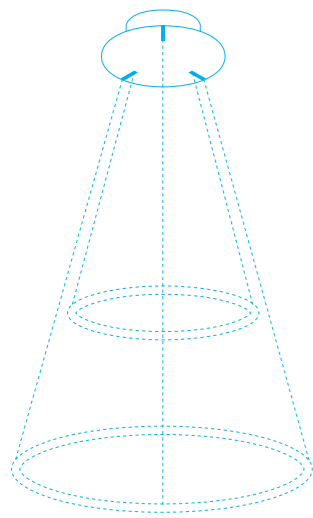

2129/R350
Rosone centrale per 2 lampade /
Central canopy for 2 lamps

H 50 mm
Ø 410 mm + Ø 350 mm

ON/OFF

AL 60-24 (S105)
AL 100-24 (S140 / S190)

DIMMERABILE / DIMMABLE D4 (TAGLIO DI FASE/PHASE CUT)

AL 75-24-D4 (S105 / S140)
AL 100-24-D4 (S190)

DIMMERABILE / DIMMABLE D6 (1-10V-DALI-PUSH)

AL 60-24-D6 (S105)
AL 100-24-D6 (S140 / S190)

DIMMERABILE / DIMMABLE D7 (ZIGBEE)

AL 60-24-D7 (S105)
AL 100-24-D7 (S140 / S190)

DIMMERABILE / DIMMABLE D8 (CASAMBI)

AL 60-24-D8 (S105)
AL 100-24-D8 (S140 / S190)

* ROSONE / CANOPY

Informazioni Tecniche vai a pag. 57
Technical info go to page 57

48 ESEMPIO D'ORDINE / EXAMPLE OF ORDER

- N.1 2166/S105 C10
- N.1 2166/S140 C10
- N.1 2129/R350 - 10
- N.1 AL 60-24
- N.1 AL 100-24

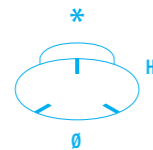
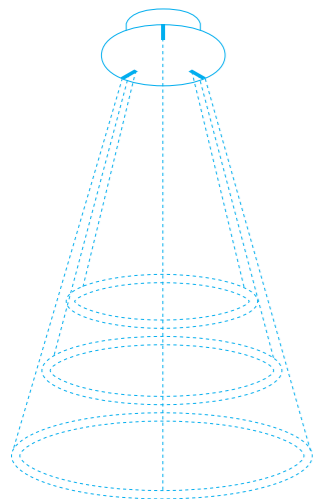

2129/R440
Rosone centrale per 3 lampade /
Central canopy for 3 lamps

H 50 mm
Ø 500 mm + Ø 440 mm

ESEMPIO D'ORDINE / EXAMPLE OF ORDER

- N.1 2166/S105 C19
- N.1 2166/S140 C19
- N.1 2166/S190 C19
- N.1 2129/R440-19
- N.1 AL 75-24 - D4
- N.1 AL 75-24 - D4
- N.1 AL 100-24 - D4

10 Bianco White	13 Foglia Argento Silver Leaf	14 Foglia Oro Gold Leaf	15 Grigio Grey	19 Nero Black	21 Grigio tortora Dove grey	22 Foglia rame Copper leaf	23 Ruggine Rust	
24 Ferro Iron	28 Oro Gold	29 Alluminio Spaz. Brushed Alum.	30 Gunmetal	31 Rosé Spaz. Brushed Rosé	32 Bronzo Spaz. Brush. Bronze	33 Oro Spaz. Brush. Gold	34 Rosé Verniciato Painted Rosé	35 Bronzo Verniciato Bronze Painted



LUMILUNA

2166/S105 + 2166/S140 + 2166/S190 + AL.60-24 + AL.100-24 + AL.100-24 + 2129/R440

Hug

50



2159/S3-2 + 2129/RO-200

BRAGA LED



51

HUG



HUG

CRI > 80

DIMMERABILE / DIMMABLE

Vai a pagina / Go to page 58

DIFFUSORE / DIFFUSER

Silicone opalino
Opaline-finish Silicone

*** ROSONE / CANOPY**

Informazioni Tecniche vai a pag. 57
Technical info go to page 57



Ø

Rosone da incasso
Recessed canopy
Max 3,2 Kg

2146/R35

Ø 45 mm

H 35 mm

Ø 35 mm

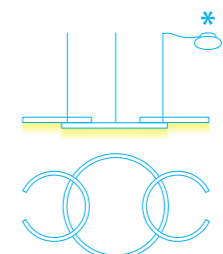

L

2159/S3-1

W 95 - Vac 230

Lm 5.700

M 2.700°K - C 3.000°K

W 4.000°K

H 35 mm

L 1.300 x 750 mm

L CAVI / CABLES 2.000 mm

ROSONE / CANOPY

H 45 mm

Ø 280 mm + Ø 220 mm

DIMMERABILE / DIMMABLE

2159/S3-1 - D4

Taglio di fase / Phase Cut

2159/S3-1 - D6

1-10V - DALI - PUSH

2159/S3-1 - D7

ZigBee

2159/S3-1 - D8

CASAMBI

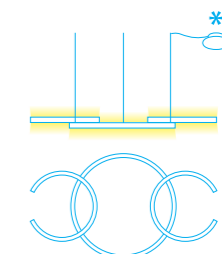

L

2159/S3-2

W 190 - Vac 230

Lm 11.400

M 2.700°K - C 3.000°K

W 4.000°K

H 35 mm

L 1.300 x 750 mm

L CAVI / CABLES 2.000 mm

ROSONE / CANOPY

H 45 mm

Ø 320 mm + Ø 260 mm

DIMMERABILE / DIMMABLE

2159/S3-2 - D4

Taglio di fase / Phase Cut

2159/S3-2 - D6

1-10V - DALI - PUSH

2159/S3-2 - D7

ZigBee

2159/S3-2 - D8

CASAMBI

10 Bianco White	13 Foglia Argento Silver Leaf	14 Foglia Oro Gold Leaf	15 Grigio Grey	19 Nero Black	21 Grigio tortora Dove grey	22 Foglia rame Copper leaf	23 Ruggine Rust	
24 Ferro Iron	28 Oro Gold	29 Alluminio Spaz. Brushed Alum.	30 Gunmetal	31 Rosé Spaz. Brushed Rosé	32 Bronzo Spaz. Brush. Bronze	33 Oro Spaz. Brush. Gold	34 Rosé Verniciato Painted Rosé	35 Bronzo Verniciato Bronze Painted

BICOLORE / TWO-TONE

Vai a pagina / Go to page 56

19 Nero Black /	24 Ferro Iron /	10 Bianco White /
14 Foglia Oro Gold Leaf	13 Foglia Argento Silver Leaf	22 Foglia rame Copper leaf

Colori / Colors

54

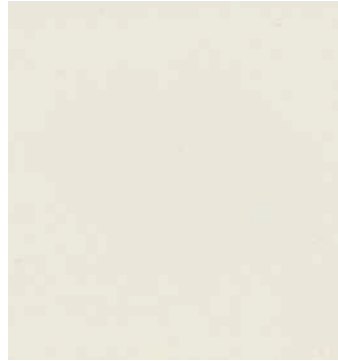

10
Bianco / *White*
RAL 9010



11
Cromo / *Chrome*



12
Nickel / *Nickel*

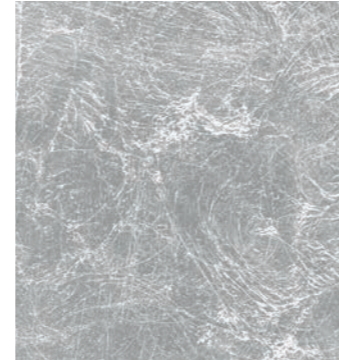

13
Foglia argento / *Silver leaf finish*

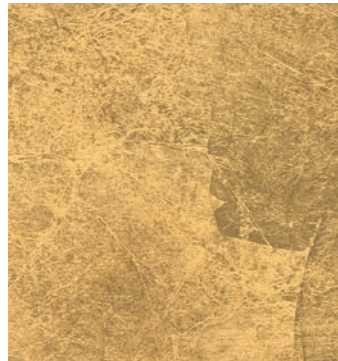

14
Foglia Oro / *Gold Leaf*



15
Grigio / *Gray*

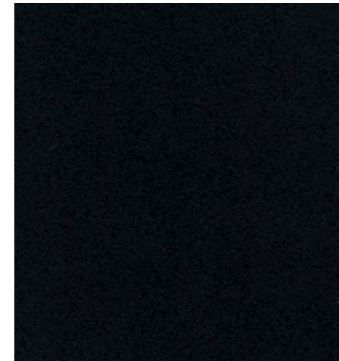

19
Nero / *Black*
RAL 9005

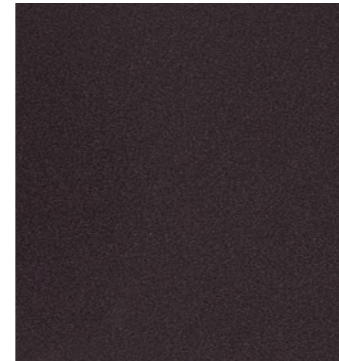

20
Corten / *Corten*
RAL 8019



21
Grigio tortora / *Dove grey*
RAL 1019



22
Foglia rame / *Copper leaf finish*



23
Ruggine / *Rust*



24
Ferro / *Iron*

Colori / Colors

55



26
Inox / *Inox*



27
Ossidato / *Oxydized*



28
Oro / *Gold*



29
Alluminio Spazzolato / *Brushed Aluminum*



30
Gunmetal

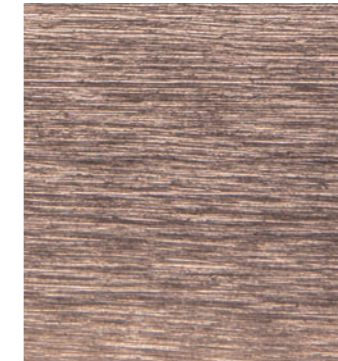

31
Rosè Spazzolato / *Brushed Rosè*

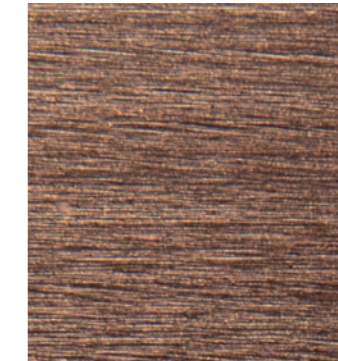

32
Bronzo Spazzolato / *Brushed Bronze*



33
Oro Spazzolato / *Brushed Gold*



34
Rosè Verniciato / *Painted Rosè*
(DJIBOUTI SABLÉ)



35
Bronzo Verniciato / *Bronze Painted*
(PATAH 2525)

BICOLORE · Informazioni Tecniche / TWO-TONE · Technical info

Combinazioni cromatiche per serie / Color combinations by series:
 GEOMETRIC / NETS / HUG / LOOP / FLAT / SPIRA / ROUND

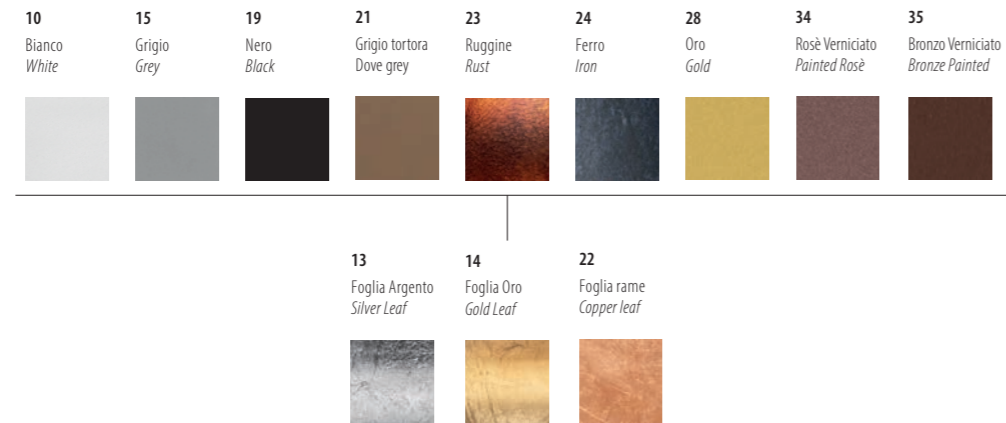

56

Esempio bicolore serie NETS / NETS series two-color example

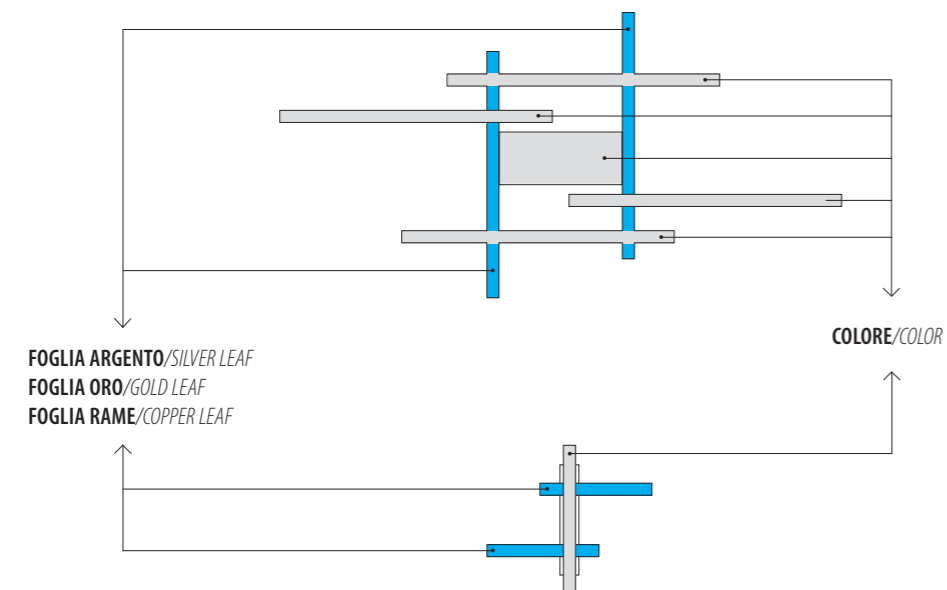

ROSONE · Informazioni Tecniche / CANOPY · Technical info

ROSONE STANDARD BIANCO
 WHITE STANDARD CANOPY

ROSONE STANDARD COLORATO
 STANDARD COLORED CANOPY

ROSONE MONOCOLORE SU RICHIESTA
 ON REQUEST MONOCOLOUR CANOPY

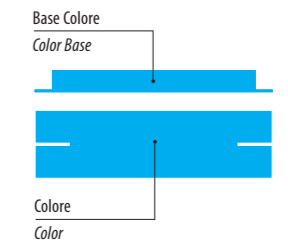
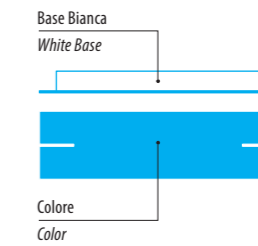
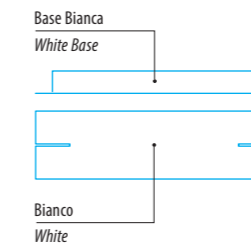
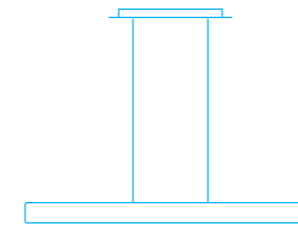

57

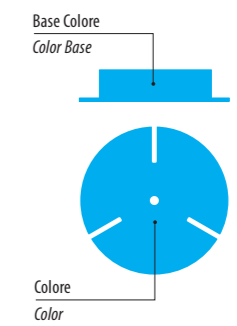
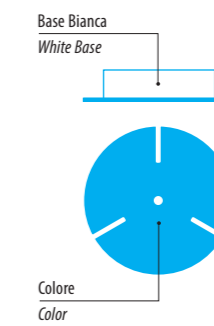
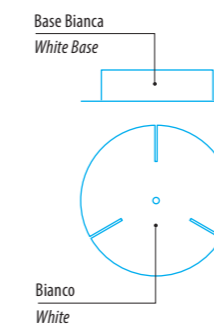
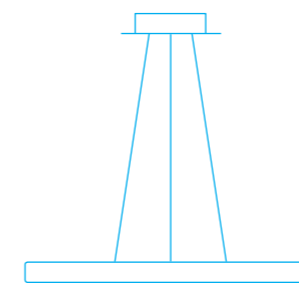
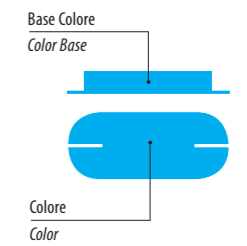
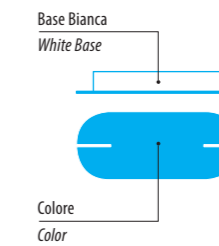
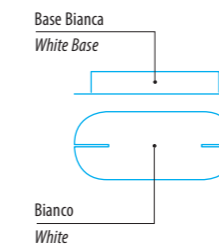
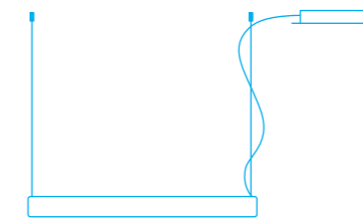

D4

DIMMERABILE / DIMMABLE

TAGLIO DI FASE / PHASE CUT

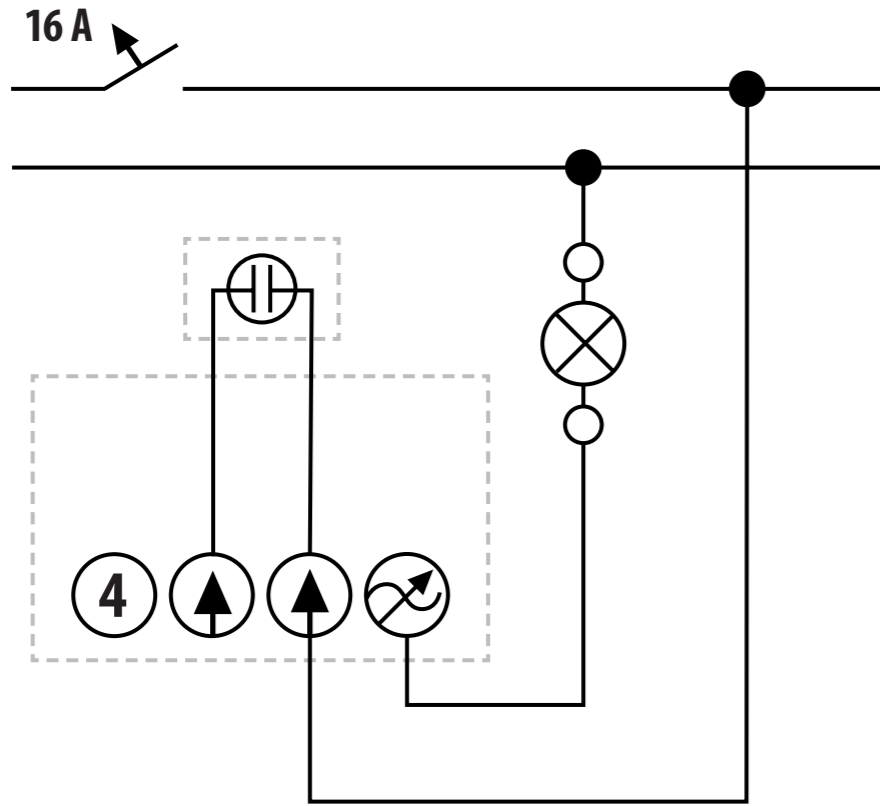

58

D6

DIMMERABILE / DIMMABLE

1-10V - DALI - PUSH

Modalità 0-10V/1-10V PASSIVO

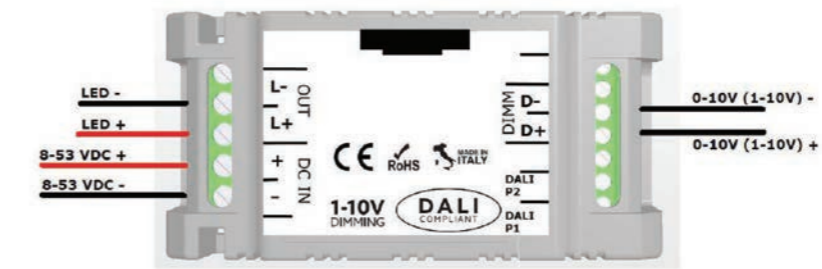

Modalità PUSH

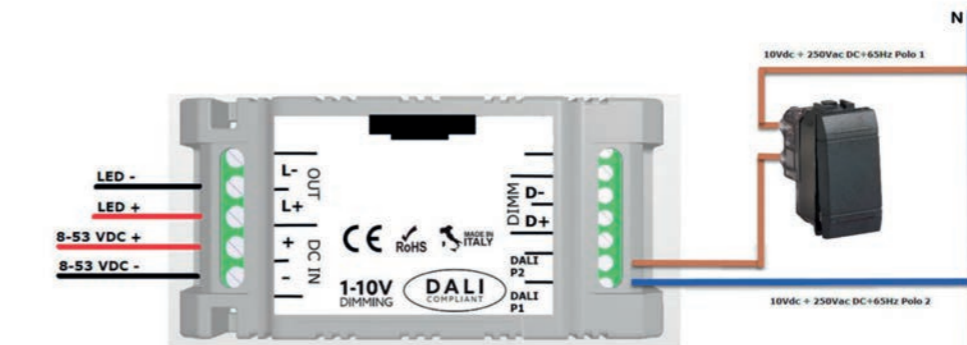

Modalità DALI

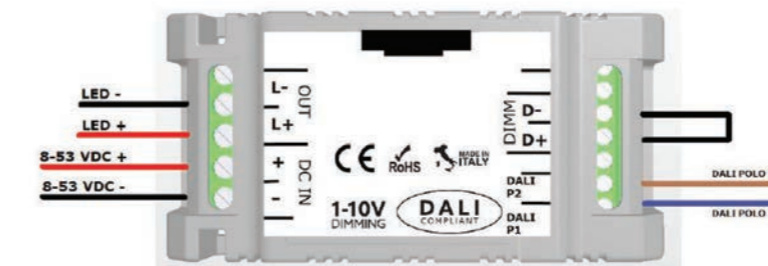

D7

DIMMERABILE / DIMMABLE

DISTANZA MASSIMA SEGNALE 8m / MAXIMUM SIGNAL DISTANCE 8m



GEOMETRIC - NETS - HUG - LOOP - SPIRA - ROUND - CLOCK - FLAT - LINK - SCIA - TAPE

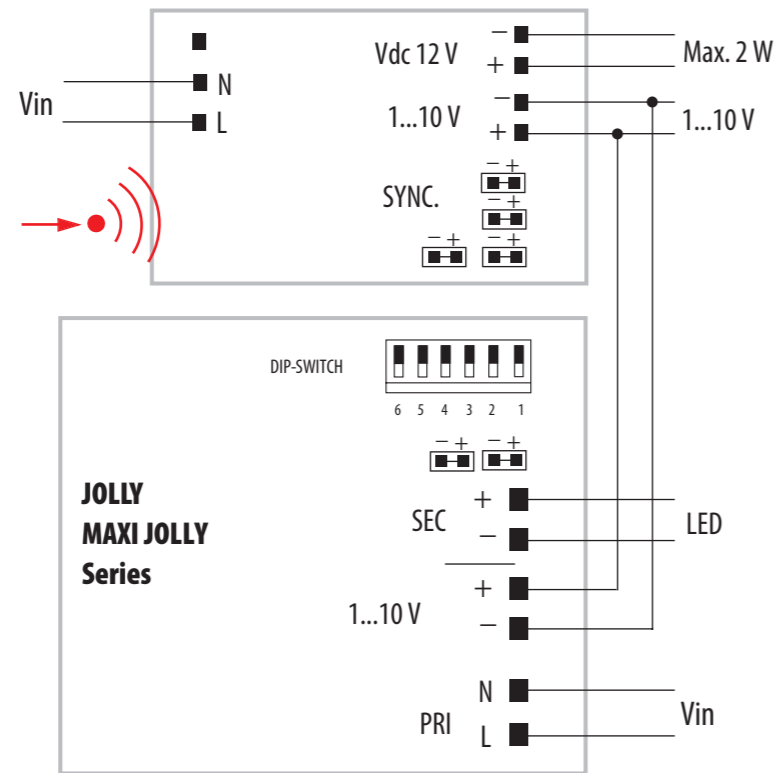

Funziona con / It works with:
Alexa, Google Home, Philips Hue dimmer switch

PATTERN - CRISTALLI

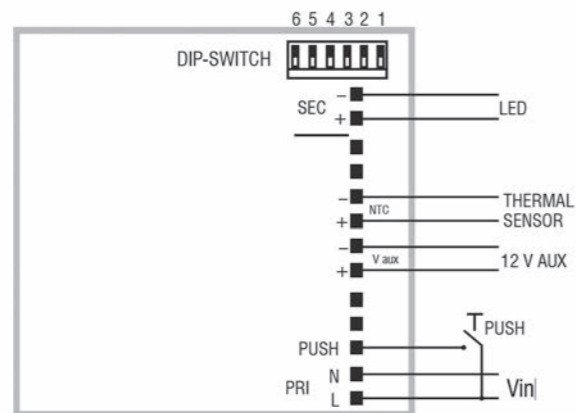

PUSH diagram - Collegamento PUSH

D8

DIMMERABILE / DIMMABLE

DOWNLOAD APP

DISTANZA MASSIMA SEGNALE 8m / MAXIMUM SIGNAL DISTANCE 8m



GEOMETRIC - NETS - HUG - LOOP - SPIRA - ROUND - CLOCK - FLAT - LINK - SCIA - TAPE

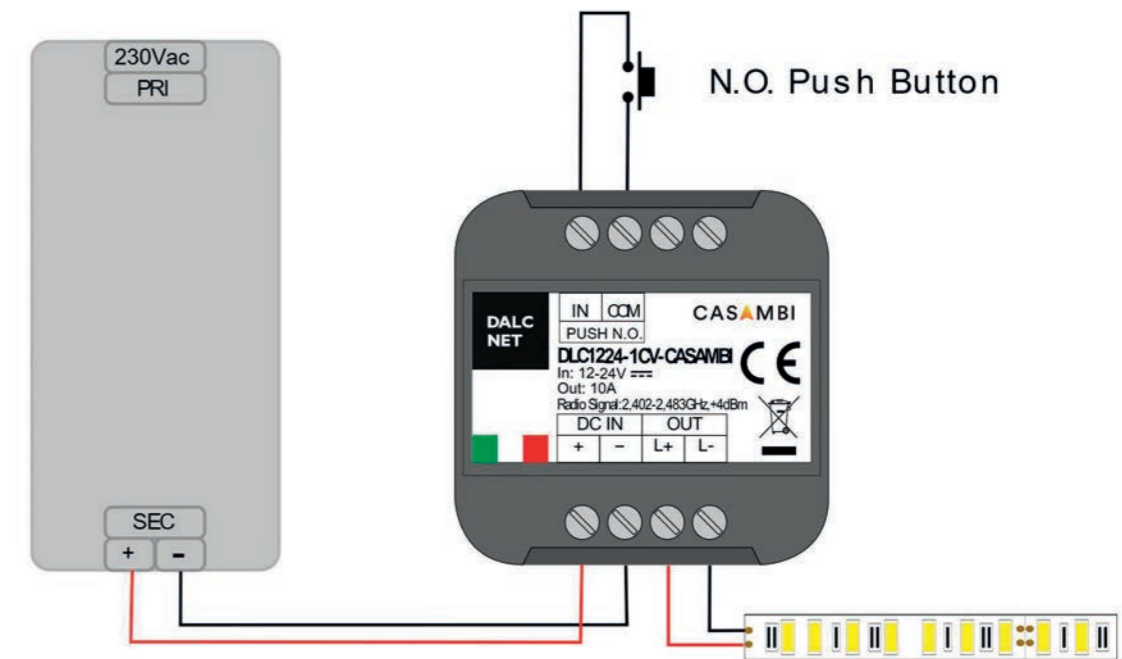

PATTERN - CRISTALLI

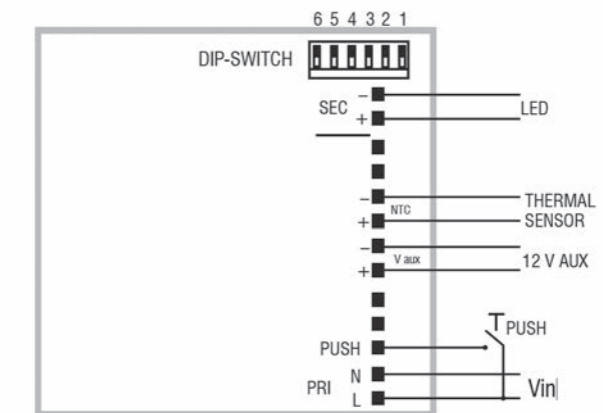

PUSH diagram - Collegamento PUSH

DIMMERABILE / DIMMABLE 230 Vac

1° OPZIONE/OPTION

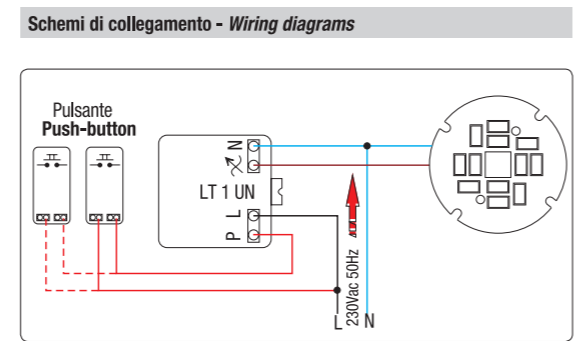
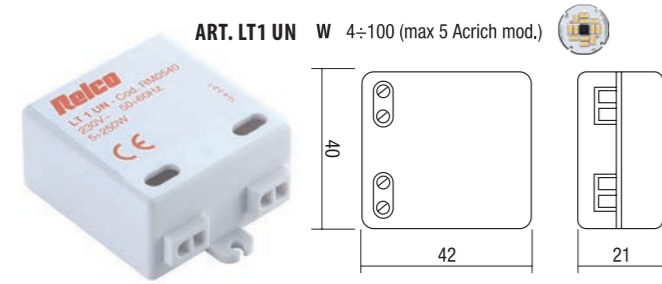

Regolatore da incasso universale con comando a pulsante separato LT 1 UN è in grado di comandare:

- Lampadine a incandescenza e alogene
- Lampadine a LED dimmerabili
- Moduli Acrich - Acrich 2
- Lampade fluorescenti dimmerabili

L'accensione e lo spegnimento avvengono per mezzo di una breve pressione (inferiore a 0,3 sec.) su un pulsante (non utilizzare pulsanti con spia luminosa incorporata). Per ottenere la regolazione dell'intensità luminosa premere il pulsante fino al raggiungimento dell'intensità desiderata, a livello raggiunto interrompere la pressione. Qualora si desideri invertire il senso di regolazione, interrompere la pressione e ripristinarla. Allo spegnimento il livello viene memorizzato, salvo interruzioni di rete. Il comando a pulsante, offre anche la possibilità di abbinare ricevitori infrarosso e/o onde radio per ottenere un comando a distanza.

Selezione del tipo di carico
LT 1 UN è in grado di adattarsi a qualunque tipo di carico impostando tramite dip-switch (posti nella parte posteriore) il funzionamento desiderato. La selezione deve essere effettuata in assenza di tensione di rete.

Caratteristiche Tecniche

- Assenza di ronzio acustico
- Collegamento con morsetteria
- Grado di protezione IP00
- Potenza dissipata 2W/A
- Conforme EN61058-1

Universal recessed dimmer with separate push-button control
LT 1 UN can control:

- Incandescent and halogen lamps
- Dimmable LED lamps
- Acrich LED modules - Acrich 2 LED modules
- Dimmable fluorescent lamps

The switching on and off takes place by means of a short touch/press (less than 0,3 seconds) of a push-button (do not use buttons with incorporated indicator light). To achieve the light intensity adjustment, press the push-button until the desired intensity level is reached; once this intensity is reached, stop pressing. If the regulation direction needs to be changed, interrupt the contact and reset the direction. The regulation level is memorised at switch-off, unless the network is interrupted.

The push-button control also offers the possibility to combine infra-red receivers and/or radio waves obtaining remote control.

Selection of the type of load
LT 1 UN is able to adapt to any type of load by setting, with the dip-switches (placed in the back), the desired function.

Technical features

- No acoustic buzzing
- Connection to a pole terminal board
- IP00 protection degree
- 2W/A dissipated power
- Compliant with EN61058-1

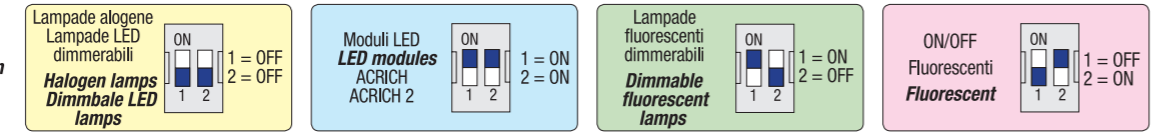

Selezione Dip-Switch - Dip-Switch selection

Adatto per installazione in scatola di derivazione o in scatola 503
Suitable for installation in junction box or in box type 503

2° OPZIONE/OPTION



W (min. max)	V	Hz	Mod	PCS	CCM cm³
10÷400 - max 40 lampadine LED/LED lamps	220-240	50	4 DIN NO SI	1	589,05
25÷600 - HALO lamps	220-240	50	4 DIN NO SI	1	589,05

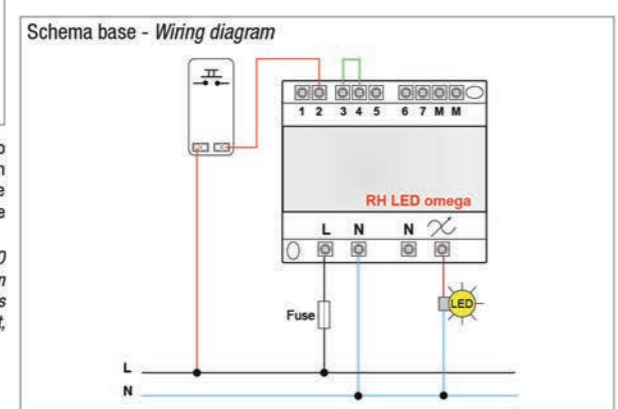

Variatore per barra DIN. La regolazione avviene per mezzo di pulsanti NA (non a corredo). RH LED è realizzato con tecnologia IGBT, adatto alla regolazione di lampade alogene e lampade LED dimmerabili, è dotato inoltre di soft-start, e protezioni; termica - sovraccarico e corto circuito.

Dimmer for DIN track. Apparatus regulated by NO push-button switches (not supplied). The RH LED has been developed with IGBT technology, suitable for halogen lamps and dimmable LED lamps. It also equipped with Soft-Start, thermal, over load and short circuit protection.

Trailing edge technology (IGBT)

3° OPZIONE/OPTION

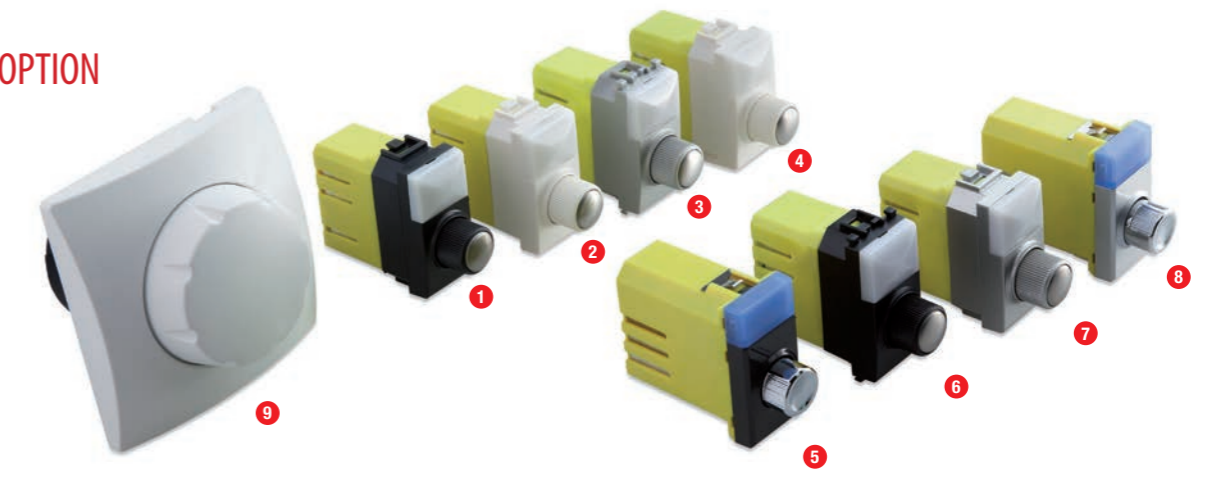

Art.	Serie	W	Vac	Hz
1	DIMLED 34 DSL	International	4÷100 (max 5 Acrich mod. - max 5 lamp)	230 50
2	DIMLED 34 DLT	Light	4÷100 (max 5 Acrich mod. - max 5 lamp)	230 50
3	DIMLED 34 DTC	Light Tech	4÷100 (max 5 Acrich mod. - max 5 lamp)	230 50
4	DIMLED 34 DVP	Vimar Plana	4÷100 (max 5 Acrich mod. - max 5 lamp)	230 50
5	DIMLED 34 DAX B	Axolute	4÷100 (max 5 Acrich mod. - max 5 lamp)	230 50
6	DIMLED 34 DEK A	Eikon	4÷100 (max 5 Acrich mod. - max 5 lamp)	230 50
7	DIMLED 34 DAX S	Silver Axolute	4÷100 (max 5 Acrich mod. - max 5 lamp)	230 50
8	DIMLED 34 DEK S	Eikon Next	4÷100 (max 5 Acrich mod. - max 5 lamp)	230 50
9	DIMLED 65 DAK	Ø 65mm	4÷100 (max 5 Acrich mod. - max 5 lamp)	230 50



Variatore rotativo da incasso adatto alla regolazione di:

- Lampadine a LED dimmerabili Acrich
- Moduli Acrich - Acrich 2

La potenza applicabile è pari a un minimo di 4W e un massimo di 100W. Comando diretto mediante deviatore a pressione e regolazione mediante rotazione della manopola stessa; accensione e spegnimento mediante pressione della manopola.

DIMLED... è un dimmer di ultima generazione che sfrutta le più recenti tecnologie del microprocessore.

Built-in rotary dimmer with built in way control for:

- Dimmable LED lamps Acrich
- Acrich LED modules - Acrich 2 LED modules modular series.

The minimum power is 4W and maximum is 100W. Direct command through deviator by pressure and regulation through rotation of the same handle grip; lighting and turning off through pressure of the handle grip.

DIMLED... a latest-generation dimmer which exploits the most recent micro-processor technology.

Schemi di collegamento - Wiring diagrams

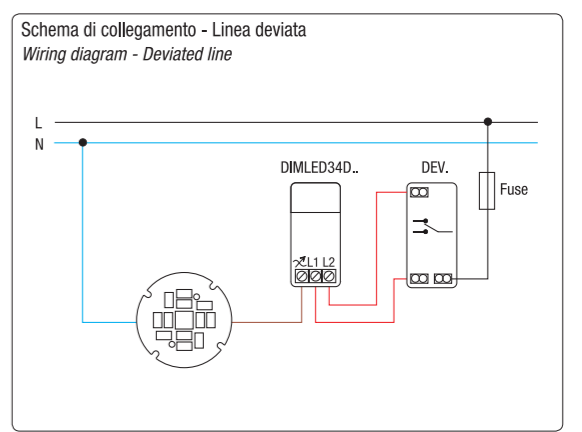
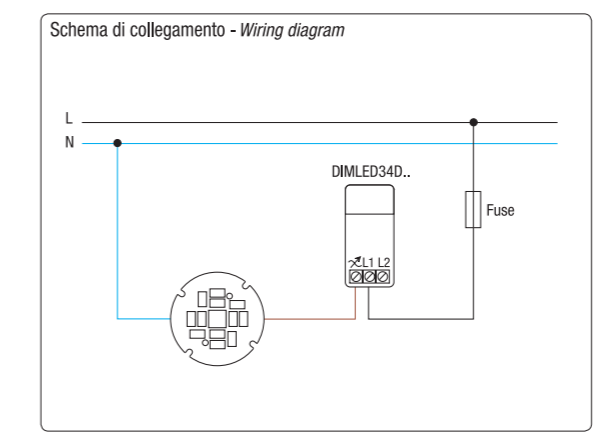

4° OPZIONE/OPTION



BUSCH JAEGER 6523U



Il marchio CE è un marchio europeo di garanzia che, rilasciato dopo una serie di rigorosi test di controllo, certifica la qualità del prodotto e la sua rispondenza ai parametri di sicurezza previsti dalle normative CE.

The CE mark is a European guarantee mark, issued after a series of strict tests, which certifies product quality and its compliance with the safety standards envisaged by EEC regulations.



Grado di protezione contro corpi solidi o liquidi.
Index protection.



Apparecchi di illuminazione nei quali le eccessive temperature che possono verificarsi in un componente a causa di un guasto, non devono surriscaldare il piano d'appoggio.
Luminaires in which the excessive temperatures which may arise due to failure of a component shall not overheat the mounting surface.



APPARECCHIO IN CLASSE II

Apparecchiature provviste di isolamento doppio o rinforzato e non aventi nessun dispositivo di collegamento a un conduttore di protezione.

CLASSE II LUMINAIRES

Luminaires supplied with double insulation and having no device for electrical bonding.



APPARECCHIO IN CLASSE I - Apparecchiature provviste di isolamento semplice: è richiesta la messa a terra di protezione.

CLASSE I LUMINAIRES - Luminaires supplied with single insulation: protective grounding is required.

BRAGA si riserva il diritto di apportare modifiche alle proprie collezioni, in qualunque momento e senza preavviso.

Braga reserves the right to modify our collections at any time it deems appropriate and without giving prior notice.



BRAGA
I L L U M I N A Z I O N E

BRAGA F.LLI s.n.c.
Via Soniga, 7
I-25080 Nuvolento
Brescia - Italy
P.Iva/CF IT 00737770172

UFFICIO VENDITE ITALIA

Tel. +39 - 030 691 775
Fax +39 - 030 691 296

info@fratellibraga.it

EXPORT SALES DPT.

Tel. +39 - 030 691 775
Fax +39 - 030 691 296
Cell. +39 - 388 974 8282

export@fratellibraga.it

www.fratellibraga.it

Realized by
studiopointer.com
© 09/2023

Printed in Italy by
EUROTEAM