

# ATELIER

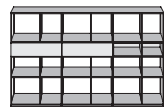

ATELIER È CONFIGURABILE UTILIZZANDO MODULI IN ACCIAIO CON SEZIONE MINIMA DI 10X10MM E CONTENITORI IN LEGNO CON DIVERSE TIPOLOGIE DI APERTURE. TELAI E CONTENITORI POSSONO ESSERE SOVRAPPOSTI E AFFIANCATI A PIACIMENTO, POSIZIONATI SU BASI O SOSPESI A PARETE. SONO DISPONIBILI ACCESSORI DA INSERIRE ALL'INTERNO DEI TELAI E TOP IN HPL O CERAMICA.



Atelier can be configured using modular elements in steel with a minimum 10x10mm cross-section as well as wooden containers with several different types of openings. Both frames and containers can be stacked and placed side by side as desired, either installed onto support bases or wall-mounted. Accessories to be integrated into the frames and tops in HPL or ceramic.

Atelier peut être configuré en utilisant des modules en acier avec une section minimum de 10x10 mm et des bacs en bois avec plusieurs typologies d'ouvertures. Châssis et bacs peuvent être superposés et associés à loisir, positionnés sur des bases ou suspendus au mur. Des accessoires sont disponibles pour l'insertion à l'intérieur des châssis et plateau en HPL ou céramique.

Bei der modularen Serie Atelier lassen sich Stahlmodule mit einer Mindeststärke von 10x10 mm mit Holzbehältern verschiedener Arten und Öffnungen kombinieren. Gestelle und Behälter können übereinander oder nebeneinander angeordnet, auf einen Unterbau gestellt oder an der Wand aufgehängt werden. Verschiedene Einsätze für die Gestelle sowie Abschlussplatten aus HPL oder Ceramic als Zubehör erhältlich.

Atelier se puede configurar utilizando módulos de acero con sección mínima de 10x10mm, así como contenedores de madera con distintos tipos de aperturas. Bastidores y contenedores, pueden colocarse uno encima del otro o uno al lado del otro, según se prefiera, posicionados sobre bases o colgados en la pared. Están disponibles accesorios que se pueden introducir en el interior de los bastidores y encimeras de laminado de alta presión (HPL) o cerámico.



## PRODUCT CONCEPT

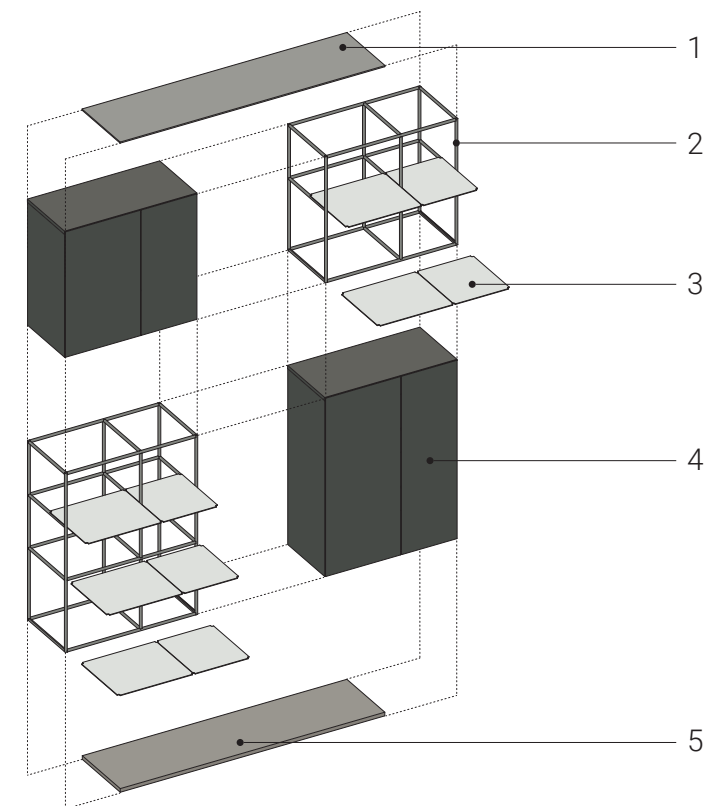

L modules  
36 - 72.5 - 108.5

H modules  
20 - 29 - 40 - 68 - 98

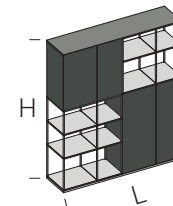

I moduli si affiancano e sovrappongono liberamente.  
The modules can be positioned side-by-side or overlapped as desired.  
Les modules se positionnent les uns à côté des autres et se superposent librement.  
Die Module können nebeneinander und übereinander frei montiert werden.  
Los módulos pueden colocarse uno al lado del otro y superponerse libremente.

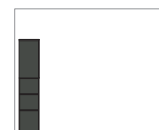

Pavimento / parete  
Floor / wall  
Sol / mur  
Boden / Wand  
Suelo / pared

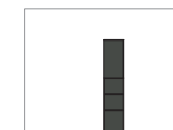

Bifacciale  
Double-sided  
Double face  
Zweiseitig  
Doble cara

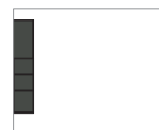

Sospeso a parete  
Suspended on the wall  
Suspendu au mur  
An der Wand hängend  
Montado en la pared



Passacavi disponibili su contenitori  
Cable sleeves available on containers  
Des passe-câbles sont disponibles sur les conteneurs  
Kabeldurchgänge auf Behälter verfügbar  
Pasacables disponibles sobre los contenedores



Il top di spessore 6mm è disponibile in molteplici finiture e raggruppa al di sotto i diversi moduli affiancati, rendendo visivamente compatta l'intera composizione.

The 6 mm thick top is available in many finishes with various side-by-side modules underneath, creating a visually compact composition.

Le plateau de 6 mm d'épaisseur est disponible en plusieurs finitions et regroupe, directement en dessous, les différents modules positionnés côte à côte, pour une composition visuellement compacte.

Das 6 mm dicke Abschlussbord ist in zahlreichen Beschichtungen verfügbar und vereint unter sich die verschiedenen nebeneinander positionierten Module und macht so die gesamte Komposition visuell kompakt.

La encimera de 6 mm de grosor está disponible en varios acabados y agrupa los diferentes módulos uno al lado del otro por debajo, haciendo que toda la composición sea visualmente compacta.



I ripiani interni ai moduli in acciaio sono in HPL. Disponibili nelle diverse varianti di finitura, vengono lavorati su tutto il perimetro per rendere minima e compatto l'accoppiamento con il modulo in acciaio.

The inside shelves of the steel modules are made of HPL. Available with a range of finishes that reach right to the edges and around the perimeter to make the coupling with the steel module minimal and compact.

Les étagères situées à l'intérieur des modules en acier sont en HPL. Elles sont disponibles en différentes variantes de finitions et sont travaillées sur tout leur périmètre pour permettre un accouplement minimal et compact avec le module en acier.

Die Einlegeböden innerhalb der Stahlmodule sind aus HPL. Sie sind in verschiedenen Beschichtungen verfügbar und werden auf dem gesamten Umfang bearbeitet, um die Verbindung mit dem Stahlmodul möglichst minimal und kompakt zu machen.

Los estantes del interior de los módulos de acero son de HPL. Disponibles en diferentes acabados, están mecanizados en todo su perímetro para que el acoplamiento con el módulo de acero sea mínimo y compacto.



I moduli in acciaio sono costituiti da barre a sezione piena 10x10 mm., predisposti per il fissaggio in sovrapposizione, affiancamento e per l'ancoraggio a parete. La finitura viene eseguita con verniciatura a polveri a 180°.

The steel modules are made of 10x10 mm full bars, designed for overlapping, side-by-side and wall fixing. 180° powder coating finish.

Les modules en acier sont constitués de barres de section pleine de 10x10 mm, conçues pour une fixation par superposition, côte à côte et un ancrage au mur. Les finitions sont réalisées par le biais d'un revêtement en poudre à 180°.

Die Stahlmodule bestehen aus massiven Stäben 10x10 mm, die übereinander, nebeneinander oder durch Verankerung an die Wand befestigt werden können. Die Beschichtung wird durch Pulverlackieren bei 180° ausgeführt.

Los módulos de acero están fabricados con barras de sección maciza de 10x10mm, preparadas para ser superpuestas, una al lado de la otra y fijadas a la pared. Están acabadas con un revestimiento de polvo a 180°.



I contenitori, disponibili in essenza e laccato, sono configurabili con frontali in HPL o vetro temprato, di soli 4mm di spessore. La semplificazione delle geometrie rende il volume compatto e raffinato.

The containers, available in wood and lacquered, can have HPL or tempered glass fronts with a thickness of just 4 mm. The simplicity of the geometries makes the unit compact and elegant.

Les conteneurs, disponibles en bois et laqués, peuvent être configurés avec des façades en HPL ou en verre trempé de seulement 4 mm d'épaisseur. La simplification des géométries rend le volume compact et épuré.

Die Behälter sind aus Holznachbildung oder lackiert verfügbar und sind mit der Stirnseite aus HPL oder Hartglas mit einer Stärke von nur 4 mm konfigurierbar. Die Vereinfachung der Formen machen das Volumen kompakt und raffiniert.

Los contenedores, disponibles en madera y lacados, pueden configurarse con frentes de HPL o de vidrio templado, de sólo 4 mm de grosor. La simplificación de las geometrías hace que el volumen sea compacto y refinado.



Le basi sono in multistrato laccato spessore 2cm. Le varianti con altezza 11 o 30cm sono sollevate da terra con un telaio in acciaio verniciato a polveri. Tutte le basi includono piedini di regolazione.

The multi-layer bases are 2 cm thick and lacquered. The versions with a height of 11 or 30 cm are raised above ground level on a powder coated steel frame. All of the bases include adjustment feet.

Les socles sont en contreplaqué laqué de 2 cm d'épaisseur. Les variantes de 11 ou 30 cm de hauteur sont surélevées par rapport au sol par le biais d'un cadre en acier peint par pulvérisation. Toutes les bases incluent des pieds de réglage.

Die Basiselemente sind aus lackiertem, 2 cm dickem Mehrschichtholz. Die Varianten mit Höhe 11 oder 30 cm sind durch ein pulverlackiertes Stahlgerüst vom Boden abgehoben. Alle Basiselemente sind inklusive Nivellierfüße.

Las bases son de madera contrachapada lacada de 2 cm de grosor. Las variantes de 11 o 30 cm de altura se levantan del suelo con un marco de acero con recubrimiento de polvo. Todas las bases incluyen pies ajustables.

## FINITURE/FINISHES

verificare a listino dimensioni e finiture  
check dimensions and finishes in the price list

### telaio / structure

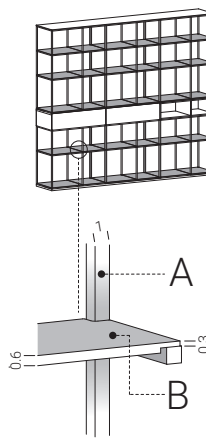

**A** acciaio verniciato painted steel

C12 bianco white	C21 seta silk	C23 corda ecru	C30 ghisa cast-iron	C14 antracite anthracite
C08 nero black	C29 bronzo bronze			

**B** POLARIS®

L03 bianco white	L10 grigio chiaro light grey	L11 grigio scuro dark grey
------------------	------------------------------	----------------------------

FENIX®

L08 grigio Londra London grey	L06 nero black
-------------------------------	----------------

HPL + legno HPL + wood

Y36 rovere oak	Y34 noce walnut	Y37 rovere affumicato smoked oak	Y40 frassino argilla clay ash	Y38 rovere nero black oak
----------------	-----------------	----------------------------------	-------------------------------	---------------------------

HPL laccato lacquered HPL

Q05 bianco white	Q16 seta silk	Q17 corda ecru	Q20 ghisa cast-iron	Q14 antracite anthracite
Q04 nero black	Q21 bronzo bronze			

### contenitori / cabinets

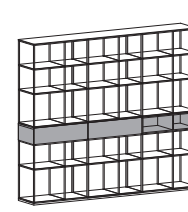

laccato lacquered

Q05 bianco white	Q16 seta silk	Q17 corda ecru	Q20 ghisa cast-iron	Q14 antracite anthracite
Q04 nero black	Q21 bronzo bronze			

essenze woods

Y36 rovere oak	Y34 noce walnut	Y37 rovere affumicato smoked oak	Y40 frassino argilla clay ash	Y38 rovere nero black oak
----------------	-----------------	----------------------------------	-------------------------------	---------------------------

laccato metallo metal lacquer

X01 rame copper	X02 ottone brass	X03 titanio titanium
-----------------	------------------	----------------------

## DIMENSIONI/DIMENSIONS

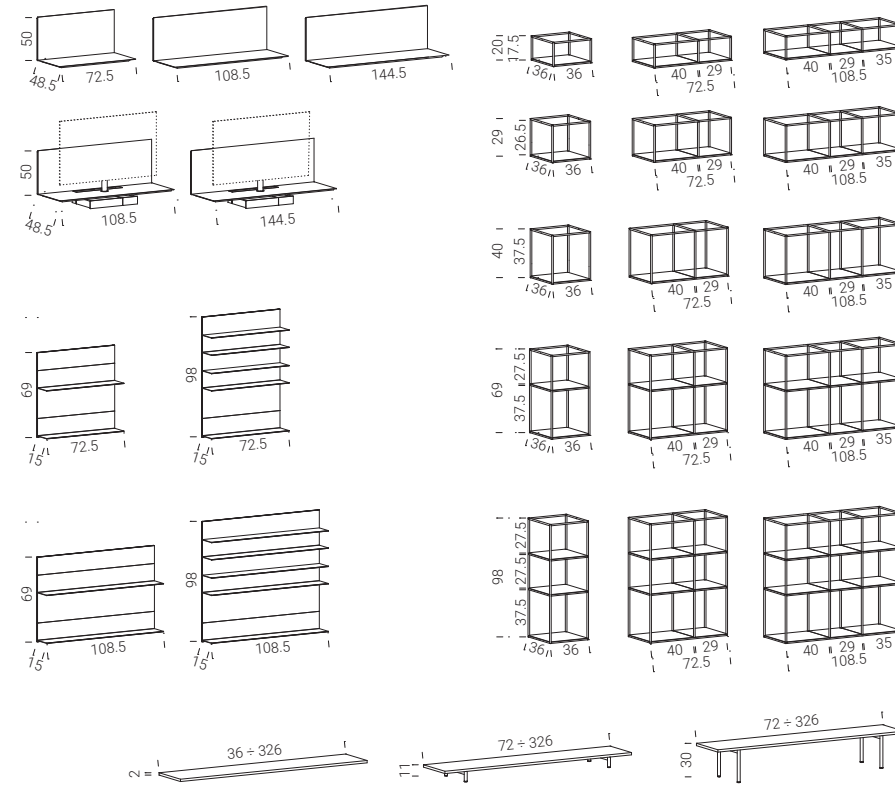

## FINITURE/FINISHES

verificare a listino dimensioni e finiture  
check dimensions and finishes in the price list

### moduli interni / internal modules



**A** acciaio verniciato painted steel

C12 bianco white	C21 seta silk	C23 corda ecru	C30 ghisa cast-iron	C14 antracite anthracite	C08 nero black	C29 bronzo bronze
------------------	---------------	----------------	---------------------	--------------------------	----------------	-------------------

**B** MDF laccato lacquered MDF

Q05 bianco white	Q16 seta silk	Q17 corda ecru	Q20 ghisa cast-iron	Q14 antracite anthracite	Q04 nero black	Q21 bronzo bronze
------------------	---------------	----------------	---------------------	--------------------------	----------------	-------------------

MDF legno MDF wood

Y37 rovere affumicato smoked oak	Y38 rovere nero black oak
----------------------------------	---------------------------

### top

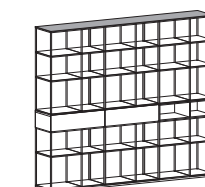

POLARIS® / FENIX®

L03 bianco white	L10 grigio chiaro light grey	L11 grigio scuro dark grey	L08 grigio Londra London grey	L06 nero black
------------------	------------------------------	----------------------------	-------------------------------	----------------

HPL + legno HPL + wood

Y36 rovere oak	Y34 noce walnut	Y37 rovere affumicato smoked oak	Y40 frassino argilla clay ash	Y38 rovere nero black oak
----------------	-----------------	----------------------------------	-------------------------------	---------------------------

HPL laccato lacquered HPL

Q16 seta silk	Q17 corda ecru	Q20 ghisa cast-iron	Q14 antracite anthracite	Q21 bronzo bronze
---------------	----------------	---------------------	--------------------------	-------------------

ceramica ceramic

S05 antracite anthracite	S06 nero black	S07 porfido porfido	S08 Cardoso Cardoso
--------------------------	----------------	---------------------	---------------------

## DIMENSIONI/DIMENSIONS

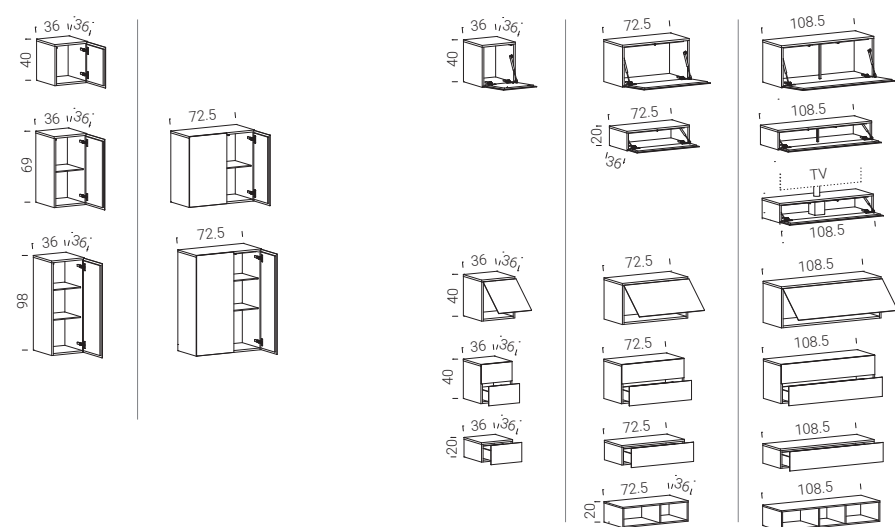
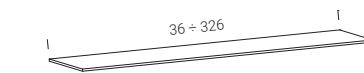
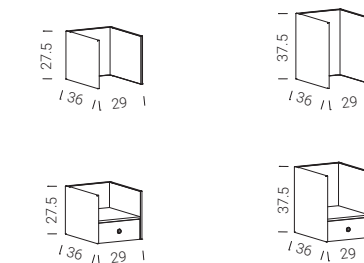



09/ATELIER

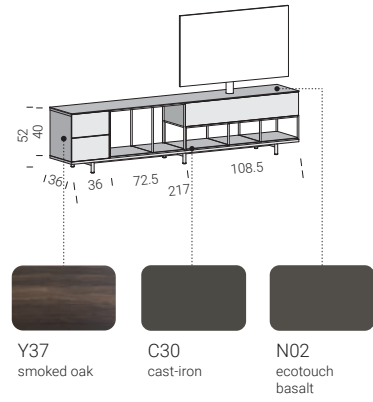

SPILLO pg. 172



CONTRAPPESO pg. 340

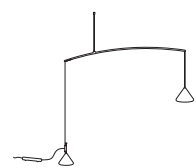



02/ATELIER

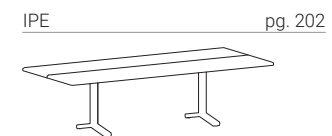
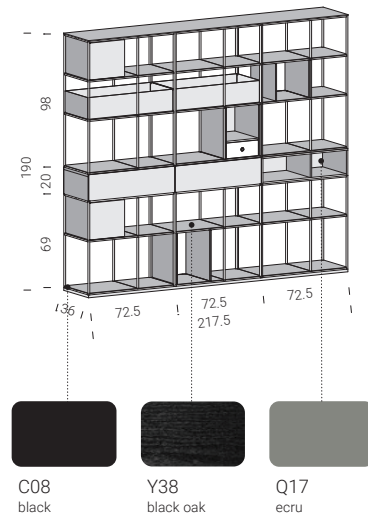



04/ATELIER

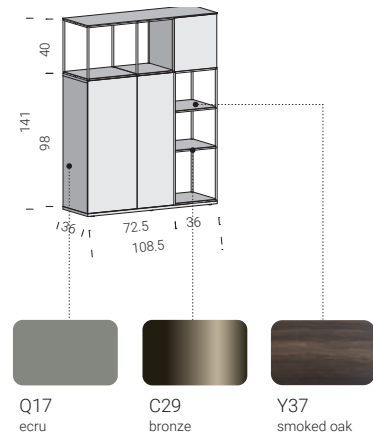

VIKING pg. 294



SPILLO pg. 172



BALANCE pg. 142





01/ATELIER

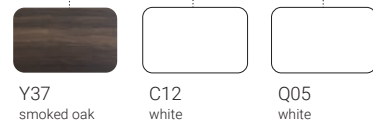
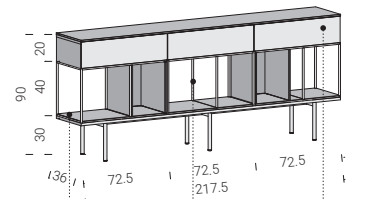



12/ATELIER

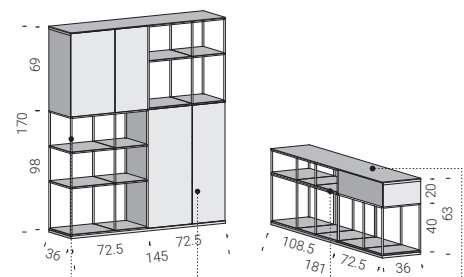

- C30 cast-iron
- Q20 cast-iron
- C08 black
- L06 FENIX® black

ECH4 pg. 308



ST35 pg. 186



CONTRAPPESO pg. 340

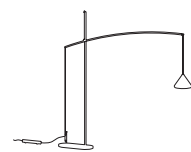



03/ATELIER

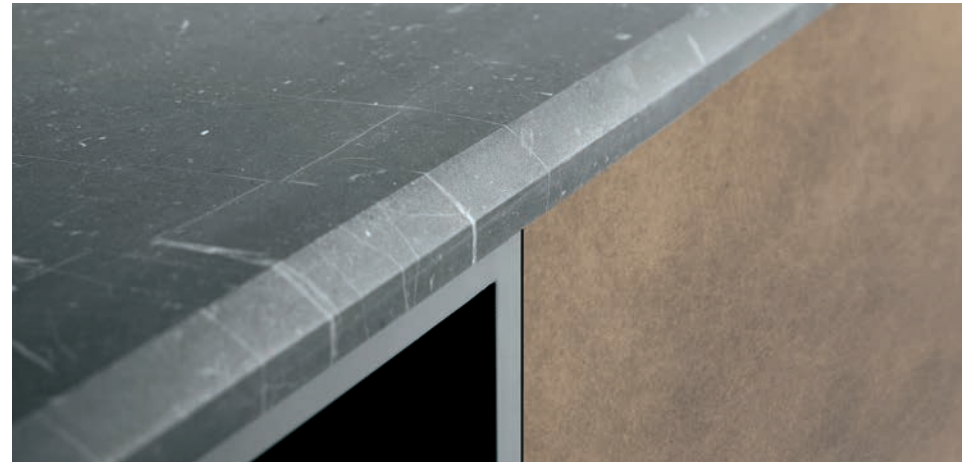
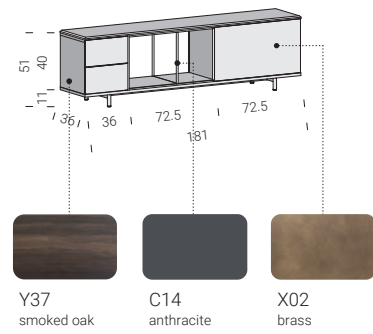



11/ATELIER

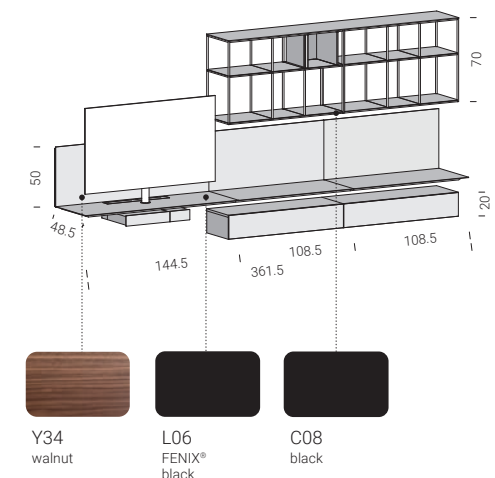

- ATELIER**
- ▶ Dettaglio anta
  - ▶ Detail of a door
  - ▶ Détail de la porte
  - ▶ Türdetail
  - ▶ Detalle de la puerta





10/ATELIER

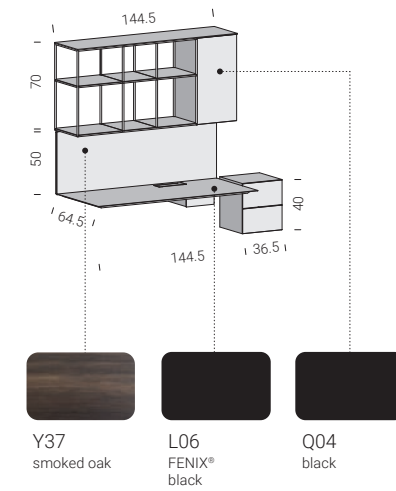



13/ATELIER

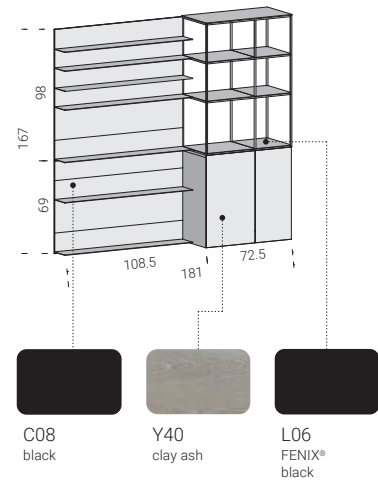

ECH5 pg. 314



T7 pg. 218





05/ATELIER

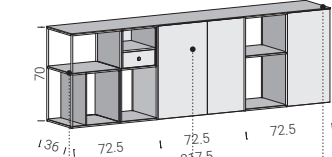
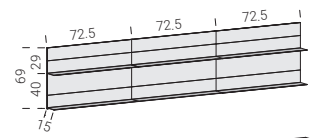

- C14 anthracite
- Q14 anthracite
- Y37 smoked oak



SPILLO pg. 172



T8 pg. 224

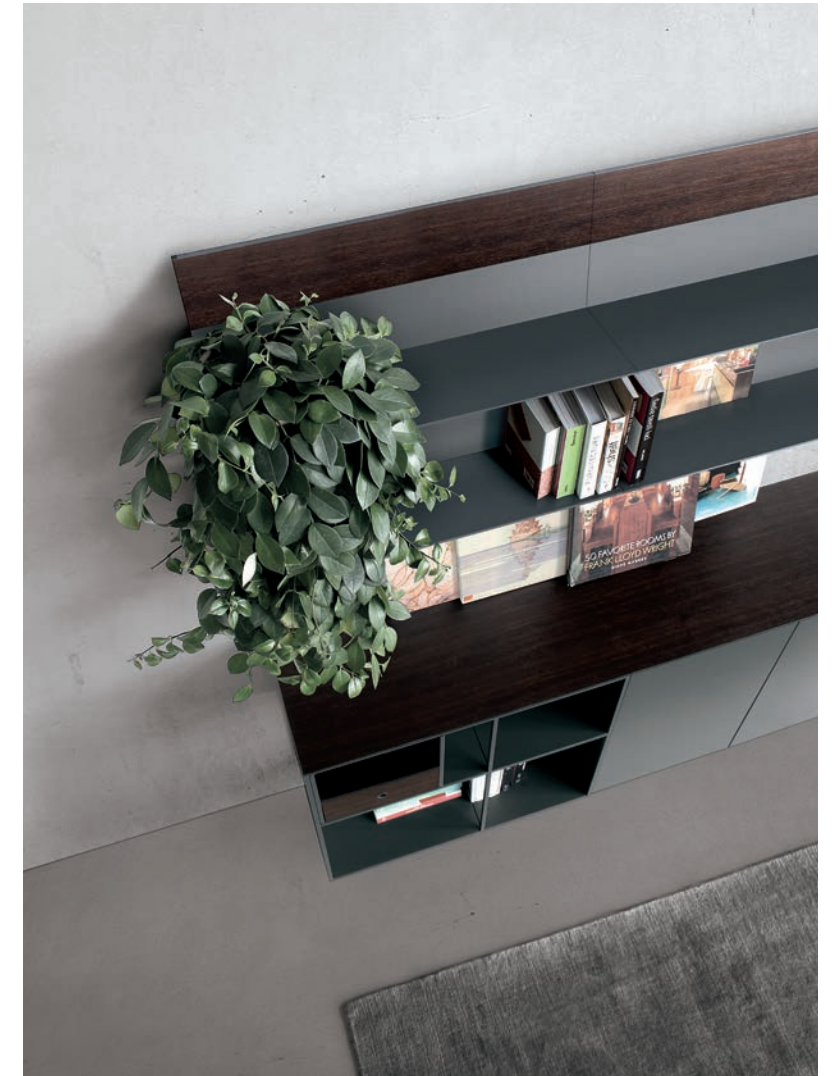
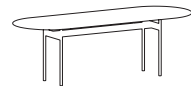



06/ATELIER

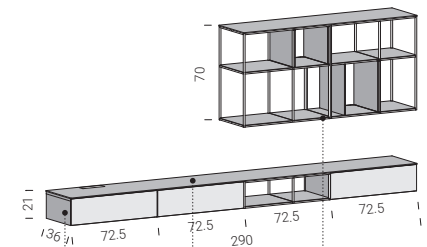

- Y37 smoked oak
- L06 FENIX® black
- C08 black





07/ATELIER

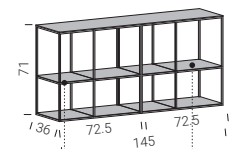

- C08 black
- L06 FENIX® black



08/ATELIER

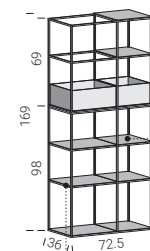

- C08 black
- L06 FENIX® black

