

Kollektionen | Collections



Nicht gross, sondern genau richtig – das war immer der Grundsatz unserer FSM Philosophie.

Keine Orientierung an modischen Strömungen, vielmehr das Festhalten am Wesentlichen. Wir entwickeln Sitzmöbel, die mehr können als gut aussehen. In fast jedem Produkt steckt eine kleine technische Sensation, welche über das Design hinaus den Komfort zusätzlich optimiert. Und obwohl wir bei der Fertigung an Traditionen festhalten, ist die Innovation eine der entscheidenden Kräfte unseres Erfolges. Innovativ zu sein bedeutet für uns eine hohe Bereitschaft zum Lernen und um Veränderung umzusetzen.

FSM ist ein seit Jahrzehnten bekannter und renommierter Polstermöbel-Hersteller. Für die Entwicklung und Produktion nutzt FSM den Fabrikationsstandort seiner Muttergesellschaft de Sede AG in der Schweiz. Diese qualitativ hoch stehende Manufaktur ist über die Grenzen hinweg bekannt und ein zusätzlicher Garant für Qualität, Beständigkeit und Langlebigkeit.

The FSM philosophy has always been based on the principle of quality before quantity.

Never bowing to the whims of ephemeral fashion, we have always held on to solid and lasting values. We develop seating that does more than merely look good. Virtually every product contains a small technical sensation that goes way beyond the bounds of simple design to make a contribution towards providing the ultimate in comfort. Although we cling to the tried and tested in our manufacturing processes, innovation is one of the crucial forces behind our success. To us, being innovative means showing great willingness to learn and to process change.

FSM is a well-known and renowned upholstered furniture manufacturer for decades. The high-quality seating furniture are developed and produced in Switzerland and selectively distributed worldwide. For development and production FSM uses the production site of the parent company de Sede AG in Switzerland. This high-quality manufacturer is known across borders and an additional guarantee for quality, durability and longevity.



Inhalt | Content

Sessel | Armchairs

FM-111 SHELBY	05
FM-330 CLEO	06
FM-352 FILOU	07
FM-212 SMILE	08
FM-136 HARDY – NEU / NEW 2021	09
FM-141 SKYE	10
FM-139 MATE	11
FM-360 AIK	12
FM-135 STAND UP	13
FM-131 PAVO	14
FM-133 GABO	15
FM-128 REX	16
FM-129 LOMO	17
FM-180 PLI	18
FM-190 ARC	19

Sofas

FM-230 CLARO	22
FM-270 CLARUS	23
FM-250 SESAM	24
FM-474 EASY	25
FM-441 VELAS	26
FM-540 JUNA	27

Abmessungen Dimensions	28
---------------------------------	-----------

Kontakt Contact	36
--------------------------	-----------

Sessel | Armchair





SHELBY

FM-111 | Georg Appeltshauer

Stilvoll mit harter Schale und weichem Kern. Die kissenweiche Polsterung kontrastiert mit dem schlanken Äusseren. Ein beachtlicher Kippwinkel von 17° der arretierbaren Wipfunktion sowie ein pfiffig verstecktes, schlankes Fussteil verwöhnen mit sehr gutem Komfort.

Stylish with hard shell and soft, cozy core, it boasts sumptuous upholstery that forms an intriguing contrast to its slim external lines. An impressive 17° angle of incline when the tilt function is locked, together with a cleverly concealed and slim legrest make for superb seating comfort.



► functions





CLEO

FM-330 | Georg Appeltshausen

Schlank und gleichzeitig selbstbewusst in jedem Umfeld – so präsentiert sich der Relax-Sessel Cleo. Er bietet dank seiner patentierten Mechanik einen perfekten Sitzkomfort: ohne Kraftaufwand lässt er sich stufenlos in jeder Position arretieren.

Sleek yet self-assured in any environment – that's the Cleo reclining armchair. Thanks to its patented mechanism, it offers perfect seating comfort and can be effortlessly adjusted to any position.



▼ functions





FILOU

FM-352 | Georg Appeltshausen

Seine bedienungsfreundliche Auslösemechanik erlaubt einfachste Rücken- und Fussteilverstellung ohne Kraftaufwand. Die Winkel lassen sich beliebig arretieren. Eine geniale Technik verhindert beim Ausklappen des Fussteils das Polsterstauchen und schafft eine lange Auflagefläche.

Its user-friendly adjustment mechanism makes it easy to alter backrest and legrest without effort and lock them in position at any angle desired. Its ingenious technology prevents the upholstery from bunching up when the legrest is extended to form a long smooth surface for reclining.



► functions





SMILE

FM-212 | Georg Appeltshauser

Smile bietet mit seinem patentierten Verstellmechanismus herausragenden Relaxkomfort und lässt sich simpel in jedem beliebigen Winkel arretieren. Die Rückenauslösung erfolgt intuitiv via Armteil und bietet auch bei geneigtem Rücken Unterstützung.

Smile's patented adjustment mechanism ensures outstanding relaxation and can be easily locked in position at any angle required. Backrest adjustment is initiated intuitively by moving the armrest and provides excellent support even when the back is inclined.



► functions





HARDY

FM-136 | FSM Design Team

Der FM-136 verspricht mit seiner speziell entwickelten, tiefen Relaxposition Erholung, Sitzfreude und Komfort. Die versteckte Fussauflage lässt sich mit einem einzigen Handgriff ausklappen und mittels Wippfunktion liegen auch die Füße entspannt auf. Ob Sie nochmals davon loskommen und aufstehen wollen? Das entscheiden Sie.

The FM-136 with its specially developed deep relaxation position promises recreation, sitting pleasure and comfort. The concealed footrest can be folded out with a single movement and the rocker function also allows your feet to lie down and relax. Whether you want to get away from it all again and get up? You decide.



▼ functions



SKYE

FM-141 | Christian Werner

Skulptur im Raum. Imposant und doch leicht anmutend, edel und doch komfortabel: der elektronisch verstellbare Motorsessel Skye. Einer Skulptur gleich, hält er jedem Blickwinkel stand. Dabei bilden Sitzfläche, Rückenlehne und Armlehne in jeder Position eine formal schlüssige Einheit.

A sculpture for living. Imposing yet light and airy, smart yet comfortable: the electrically-powered adjustable Skye armchair. Like a sculpture, it is sublimely attractive from which-ever angle it is viewed, with seating surface, backrest and armrests forming a single coherent entity in every position.



► functions





MATE

FM-139 | Georg Appeltshauer

Höchste ästhetische und ergonomische Ansprüche werden mit Mate erfüllt. Das Bedienpanel ist unsichtbar eingebaut. Nebst aktiver Ruheposition ist auch eine sehr angenehme sowie kreislaufentlastende Liegeposition möglich, die unabhängig einstellbar ist.

Mate satisfies the highest demands in terms of styling and ergonomics, with its integrated operating controls hidden away out of sight. In addition to its active rest position, it also offers a very agreeable reclining position that is good for the circulation and can be adjusted independently.



► functions

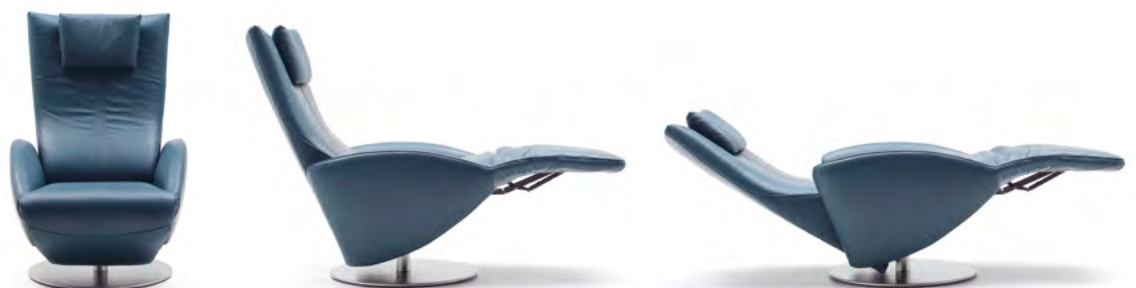



AIK

FM-360 | Georg Appeltshauer

Dank der schlanken Silhouette und dem selbstbewussten Auftritt entfaltet sich AIK mit seiner modern anmutenden Formensprache zur Skulptur im Raum. Ob zurückgelehnt beim Fernsehen, in aufrechter Rückenstellung und ausgefahrenem Fussteil zum Lesen oder in fast waagrechter Liegeposition für die perfekte Entspannung, bietet AIK immer den optimalen Komfort.

With a modern, striking design, AIK is sure to become a feature of any room thanks to its sleek silhouette and bold appearance. Whether reclined in front of the TV, upright with the footrest extended for reading, or almost horizontal for the ultimate relaxation, AIK always offers maximum comfort.



▼ functions



STAND UP

FM-135 | Georg Appeltshauser

Stand Up lässt sich elektrisch auf eine Sitzhöhe von bis zu 60 cm hochfahren, was ein bequemes Sitzen für alle Körpergrößen sowie ein leichteres Aufstehen ermöglicht. Seine stufenlos verstellbare Fussstütze sowie Sitzneigung machen den schönen Schalensessel zum vollwertigen Relaxesessel.

The seat height of Stand Up can be raised electrically when needed by up to 60 cm to allow comfortable seating for all body-heights and to facilitate standing up. Its infinitely adjustable legrest and variable angles of seat rake make this attractive shell-construction offer you the best relaxation chair.



► functions





PAVO

FM-131 | Markus Hartmann

Pavo überzeugt mit bemerkenswerten Funktionen in schlichter Eleganz. Sein höhenverstellbares Kopfkissen und die angenehm lange Fussauflage sind geschickt versteckt. Die Wippfunktion sorgt für besten Komfort, das Drehgestell für Flexibilität.

Pavo's appeal lies in its outstanding multifunctionality and sleekly elegant lines that conceal a heightadjustable head cushion and pleasantly long legrest. Its tilt function ensures peerless comfort, while its swivel base makes for practical flexibility.



► functions





GABO

FM-133 | Markus Hartmann

Der zeitlose Beistellsessel kommt entweder als eleganter Freischwinger oder als filigraner Gestellsessel mit den FSM typischen Funktionen daher. Die versteckte Kopfstütze und das Fussteil bieten, zusammen mit dem neigbaren Rücken, ungeahnte Möglichkeiten.

This timeless occasional armchair comes either in an elegant cantilever version or on a slim tubular frame and affords all the multifunctional features typical of FSM. The concealed headrest and legrest, coupled with the adjustable back provide a host of possible configurations.



► functions





REX

FM-128 | Bart Van der Heyden & FSM Design Team

Mit dem Sessel Rex wird das Sitzen revolutioniert. Rex basiert auf einer patentierten Sitzstudie, welche der Sitz-experte und Physiotherapeut Bart Van der Heyden in den letzten zwei Jahrzehnten entwickelte. Rex ist ein Sessel, der sich mit den Bewegungen des Sitzenden mitbewegt. Haltungsänderungen werden nicht nur zugelassen, sondern sogar gefördert.

The armchair Rex revolutionizes the act of sitting. Rex is based on a patented seat study developed over the last two decades by seat expert and physical therapist Bart Van der Heyden. Rex is an armchair that moves with the movements of the person seated. Changes in posture are not just permitted but even encouraged.



► functions





LOMO

FM-129 | Bart Van der Heyden & FSM Design Team

Der bewährte dynamische Bewegungsmechanismus, der dem Sitzenden ohne mechanischen Aufwand einzigartig folgt, ist auch beim Sessel FM-129 Lomo enthalten. Wie bei seinem Bruder Rex wird die Wirbelsäule schonend unterstützt und eine relaxende Sitzhaltung durch die auf Beckenhöhe verlängerte Sitzschale zusätzlich gefördert. Die weiterentwickelte Druckverteilung der Rückenlehne ermöglicht den Sitzkomfort noch weicher zu gestalten.

The proven dynamic movement mechanism, which uniquely follows the seated person without any mechanical effort, is also integrated into the chair FM-129 Lomo. As with its brother Rex, the spinal column is gently supported and a relaxing sitting posture is additionally promoted by the seat shell, which is extended to the pelvic level. The further developed pressure distribution of the backrest makes it possible to additionally improve the seating comfort.





PLI

FM-180 | Stefan Heiliger

Der Sessel Pli besteht aus zwei Sesselteilen, welche sich jeweils um ihre eigene Achse drehen. Durch die zweifache Rotationsmöglichkeit kann der Sessel eine Vielzahl an Funktionen erfüllen. Je nachdem, wie die zwei Sesselteile zueinander gedreht werden, kann der Sessel mit Armlehne, Fussteil oder einer intelligenten Ablage genutzt werden.

The chair Pli consists of two armchair parts, each rotating about its own axis. Thanks to the option of dual rotation the armchair can fulfill a variety of functions. Depending on how the two chair parts are rotated relative to one another, the armchair can be used with an armrest, a footrest or an intelligent shelf.



► functions





ARC

FM-190 | Stefan Heiliger

Der FM-190 Arc ist jenes Möbel, das sich in einem Moment noch als Sessel zeigt und im nächsten Augenblick zur komfortablen Liege wird. Durch kleine Körperverlagerungen oder sanften Druck gegen die als Faust anmutende Rückenlehne, kann die gewünschte Sitz- oder Liegehaltung ohne grossen Aufwand eingenommen werden. Die fließenden, geschwungenen Formen zeichnen die Handschrift Stefan Heiligers nach und machen aus dem FM-190 einen Hybriden der Sessel-Liege-Kultur. Abgerundet wird das einzigartige Design durch die hochwertige Lederverarbeitung.

The FM-190 is the piece of furniture that at one moment still looks like an armchair, but at the next moment it turns into a comfortable lounger. Small body shifts or gentle pressure against the backrest, resembling a fist, allow the desired sitting or reclining position to be assumed without great effort. The flowing curved shapes trace the handwriting of Stefan Heiliger and turn the FM-190 into a hybrid of a chair- and recliner culture. The unique design is rounded to perfection by the high-quality leather processing.



functions



Sofas







CLARO

FM-230 | Georg Appeltshauer

Bequem sitzen und schön aussehen. Claro kann beides. Unter der geradlinigen Form steckt jede Menge Entspannung. Ob als Sofa, Recamiere, Anbauprogramm oder Einzelsessel. Automatisch herausfahrbare Fussauflagen, hochschwenkbare Kopfstützen sowie verstellbare Rückenlehnen bieten höchsten Komfort.

Sit snugly and look good. Claro does both. Its minimal linear design offers a wealth of hidden comfort: as sofa, recamiere, modular program or individual armchair. With automatically extending legrest, fold-up headrest system and adjustable back, it provides the tops in cozy relaxation.



► functions



CLARUS

FM-270 | Georg Appeltshauer

Kein Schmuckelement stört das puristisch elegante Bild. Mittels eines integrierten Bügelsystems werden die Armteilkissen zu bequemen Nackenstützen. Wahlweise gibt es das Clarus mit Klapprückenfunktion, Stützen sowie in zwei Sitztiefen und Sitzhöhen.

No unnecessary adornment detracts from the puristic elegance of its lines. Cunningly integrated brackets transform the armrest cushions into comfy headrests. Clarus is available with fold-away back, legrests, and in a choice of two depths and heights of seat.



► functions



SESAM

FM-250 | Georg Appeltshauser

Sesam bietet spürbar mehr Entspannung, ohne dass der Körper dabei eingeknickt wird. Bei der vollumfänglichen Relaxposition neigt sich der gesamte Sitzkorpus angenehm nach hinten. Die ganze Funktionalität versteckt Sesam dezent hinter einer schicken, unaufdringlichen Form.

Sesam provides noticeably greater relaxation by allowing the body to stretch out in comfort, with the entire seating element sliding to the rear when it is in its fully reclined position. Sesam conceals this wealth of multifunctional magic behind smooth and unobtrusive lines.



► functions





EASY

FM-474 | Markus Hartmann

Die Armlehnen dieses cleveren Sofasystems lassen sich in drei Stufen neigen und bieten individuelle Relaxsituationen bis zur flachen Liegefläche. Die Sitztiefe kann bis zu 16 cm beliebig vergrößert werden. Bereits das kleine 155 cm Sofa eignet sich zum Längs-Liegen!

The armrests of this ingenious sofa system can be folded down in three stages to offer various positions for individual relaxing or to form a completely flat reclining surface. Seat depth can be increased if required by as much as 16 cm. Even the small 155 cm sofa is suitable for stretching out full length in comfort!



► functions





VELAS

FM-441 | Braun & Maniatis

Dieses formal veränderbare Sofa bietet viele Möglichkeiten zum Sitzen, Relaxen, Schlafen. Die verstellbaren Arm- und Rückenpolster sind getrennt, wodurch sich Sitzbewegungen nicht darauf auswirken. Die herausziehbare Sitzfläche bietet uneingeschränkten Komfort.

A genuine shape-shifter, this striking sofa offers a host of sitting, reclining and sleeping positions. The adjustable arm and back cushions are separated to ensure seat movements have no impact on them. The extendable seating surface is a guarantee of untrammelled comfort.



► functions





JUNA

FM-540 | FSM Design Team

Juna erweist sich als gelungene Synthese aus eleganter Form und Funktionalität. Das Sofa besitzt schlanke Füße, welche eine Sitzfläche mit zwei feinen Polstern tragen. Hinter der edlen Erscheinung versteckt sich überraschend viel Flexibilität. Juna ist dafür konstruiert, all dies zu erfüllen, was wichtig ist: fernsehen, lesen, schlafen oder einfach nur richtig ausgiebig entspannen.

Juna is quite clearly a clever symbiosis between elegant form and functionality. The sofa has slender legs that support a seat with two fine upholstered layers. The graceful appearance conceals a surprising amount of flexibility. Juna is designed to fulfill everything that is important: watching TV, reading, sleeping or even just an extended spell of relaxing.



▼ functions



FM-111
SHELBY

/11

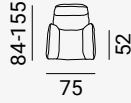
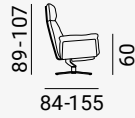
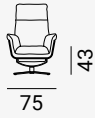

FM-128
REX

/01

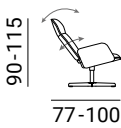
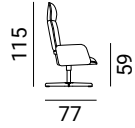

/05



FM-129
LOMO

/01

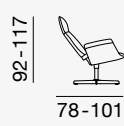
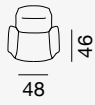
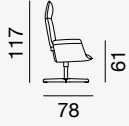

/05



FM-131
PAVO

/11

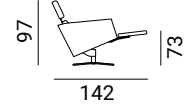
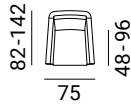
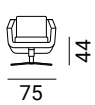

/21

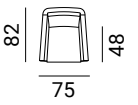
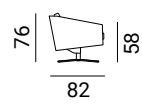
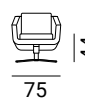

FM-133
GABO

/11

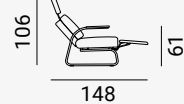
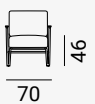

/21

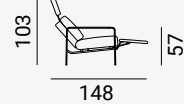
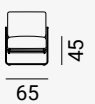

FM-135
STAND UP

/11

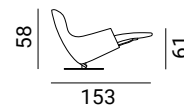
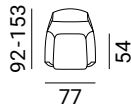
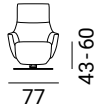

/97



/21

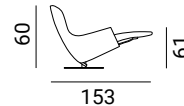
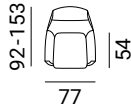
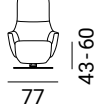

/99



FM-136
HARDY

/11

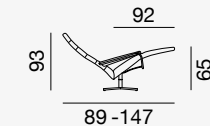
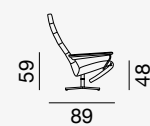

FM-139
MATE

/11

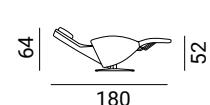
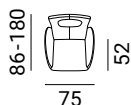
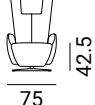

/97

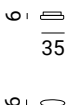
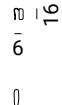
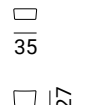

/98



FM-141
SKYE

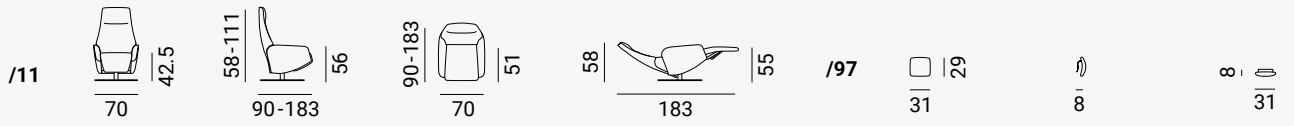

FM-180
PLI

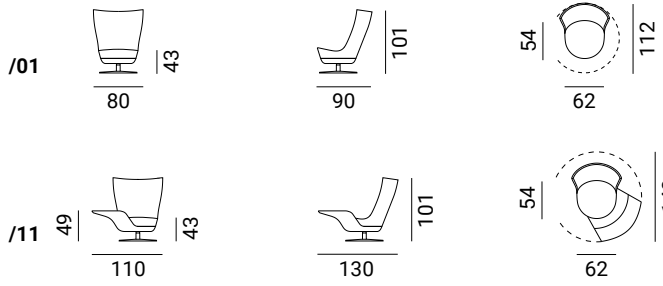

FM-190
ARC

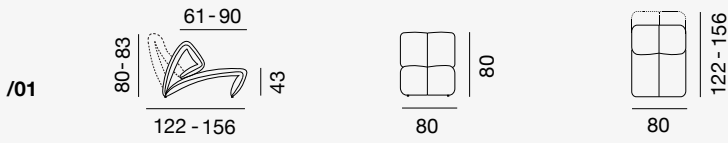

FM-212
SMILE

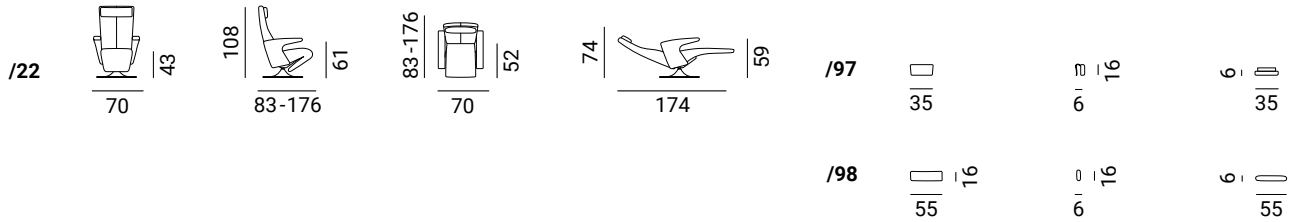

FM-330
CLEO

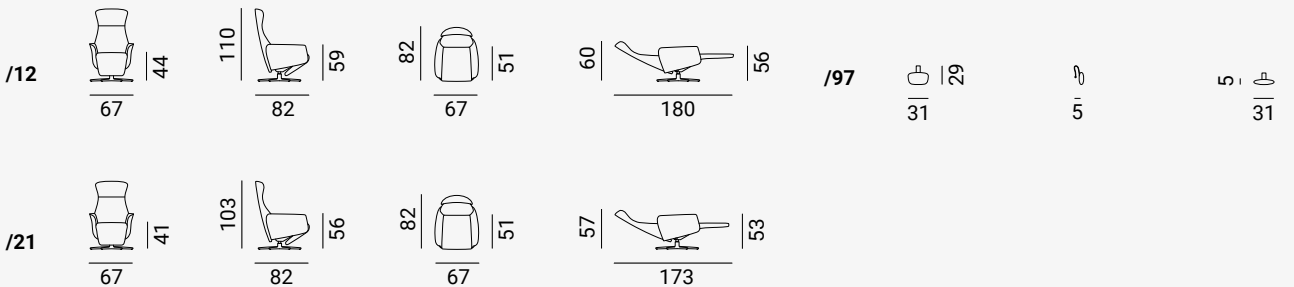

FM-352
FILOU

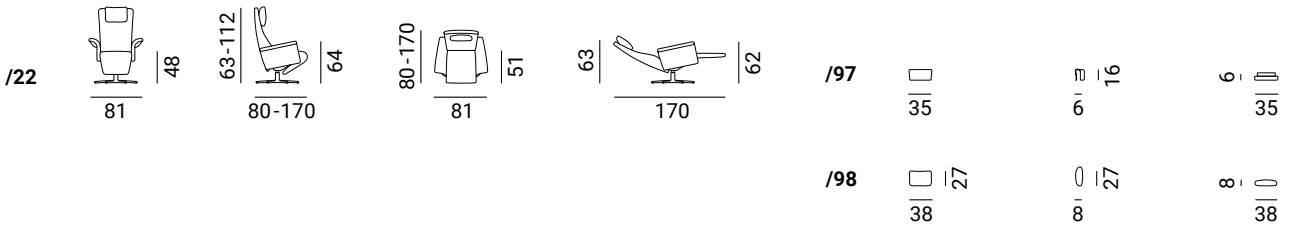

FM-360
AIK

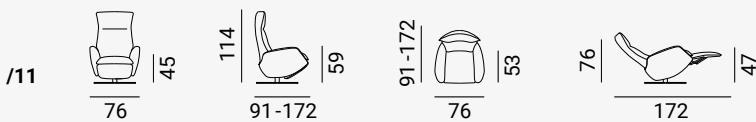

FM-230
CLARO

Sessel | Armchair



Sofa

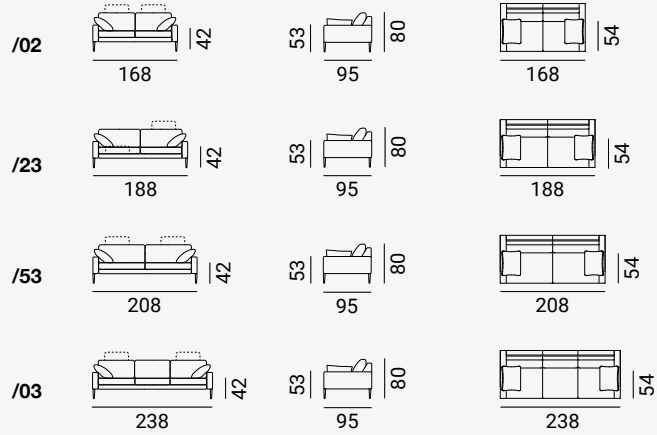

Abschlusselement links | End elements left

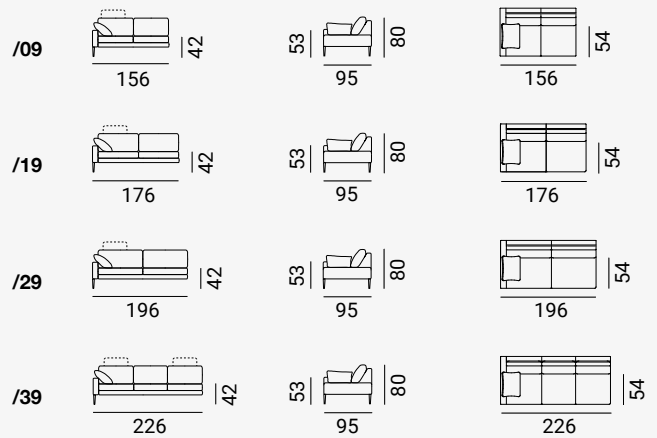

Abschlusselement rechts | End elements right

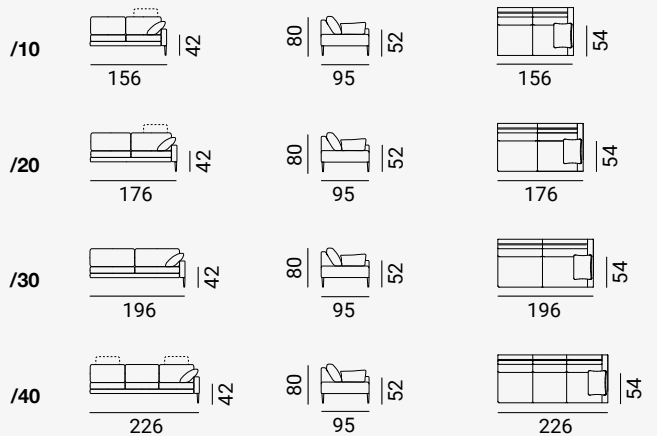

FM-230
CLARO

Sessel mit Funktion | Armchair with functions



Sofa mit Funktion | Sofa with functions

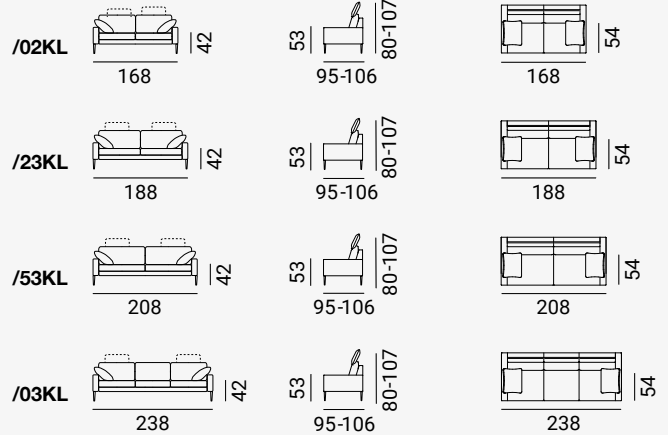

Abschlusselement links mit Funktion | End elements left functions

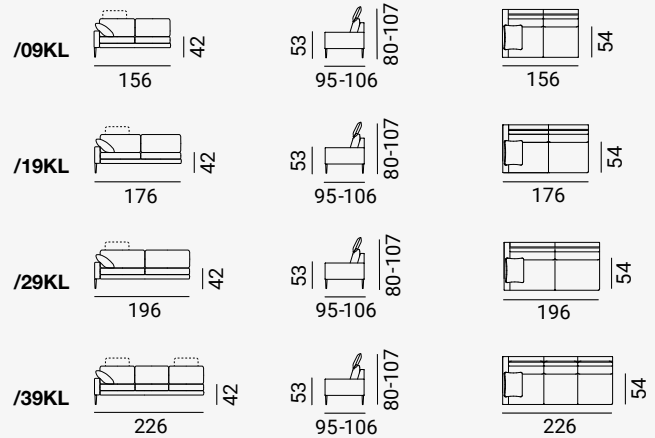

Abschlusselement rechts mit Funktion | End elements right functions

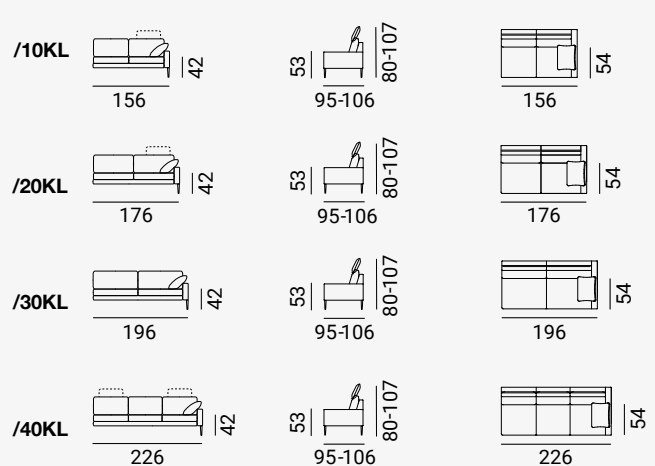

FM-230
CLARO

Recamieren | Recamieres

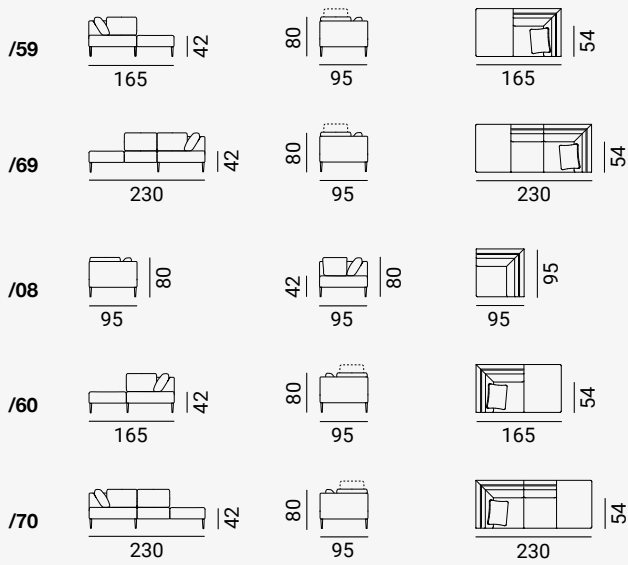

Fussteile | Lounge Chair

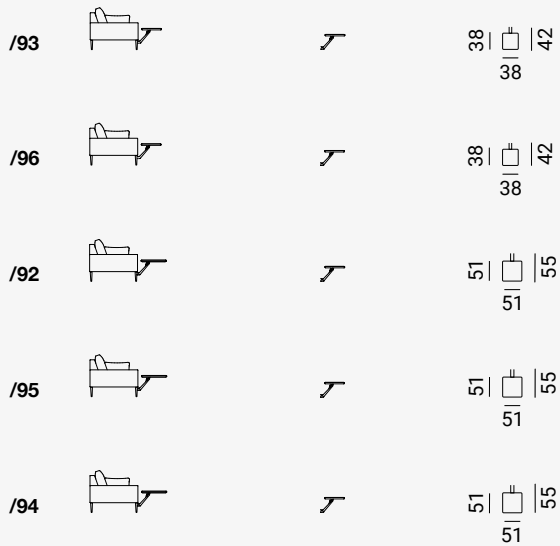

Hocker | Stool



Kissen | Cushions

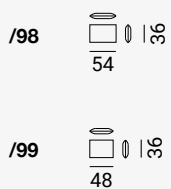

FM-250
SESAM

Sessel | Armchair

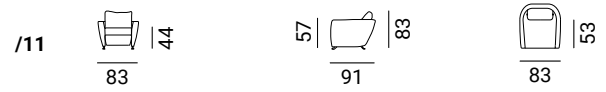

Sessel mit Funktion | Armchair with functions



Sofa

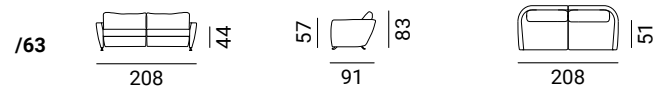
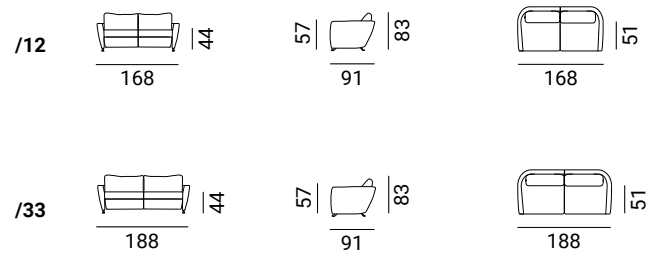

Sofa mit Funktion | Sofa with function

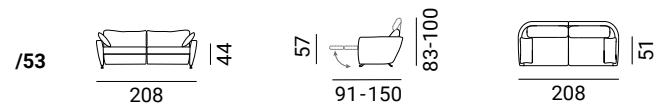
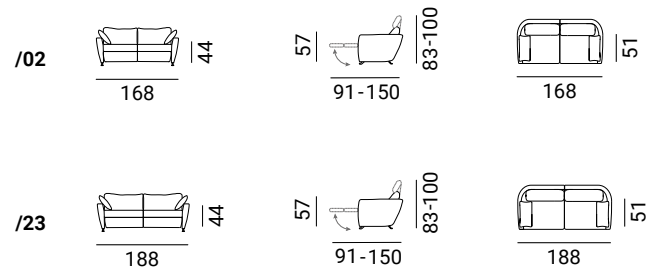

Kissen / Cushions

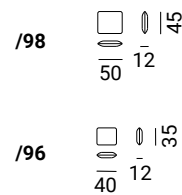

FM-270
CLARUS

Sofa

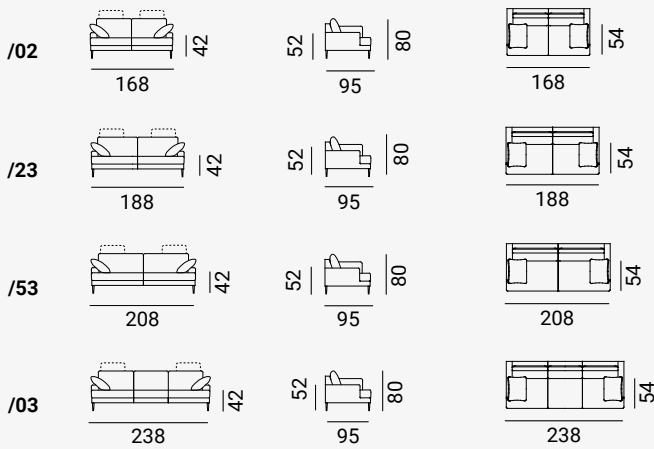

Abschlusselement links | End elements left

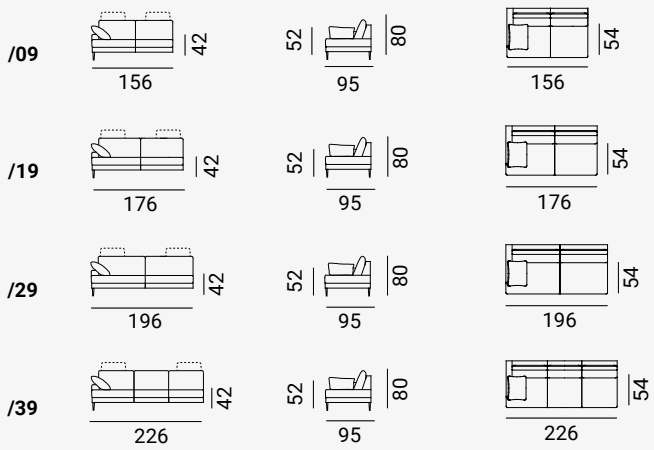

Abschlusselement rechts | End elements right

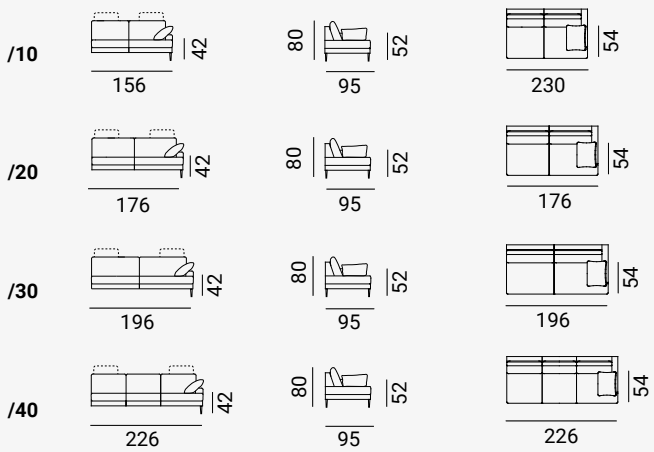

Eckelemente | Corner elements



FM-270
CLARUS

Sofa mit Funktion | Sofa with function

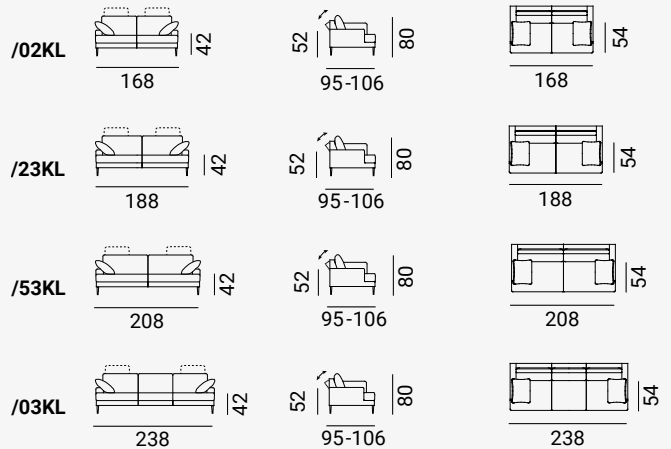

Abschlusselement links mit Funktion | End elements left functions

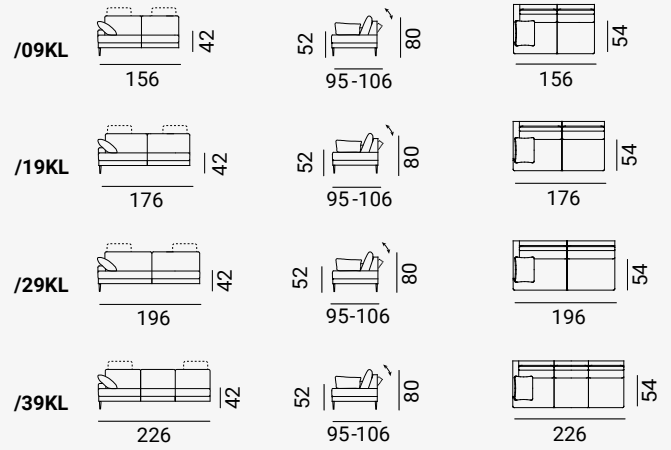

Abschlusselement rechts mit Funktion | End elements right functions

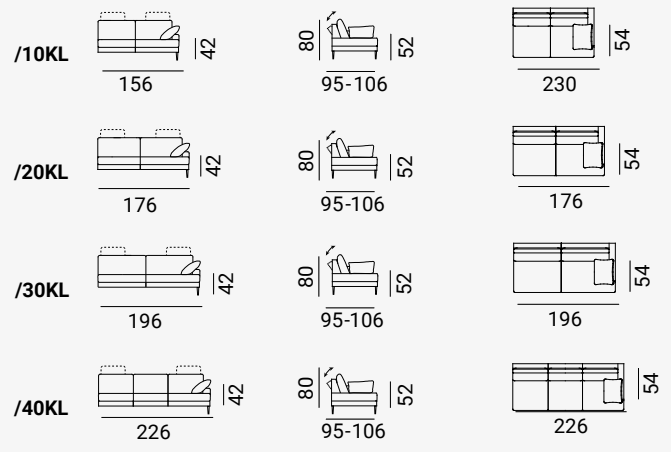

FM-270
CLARUS

Recamieren | Recamieres

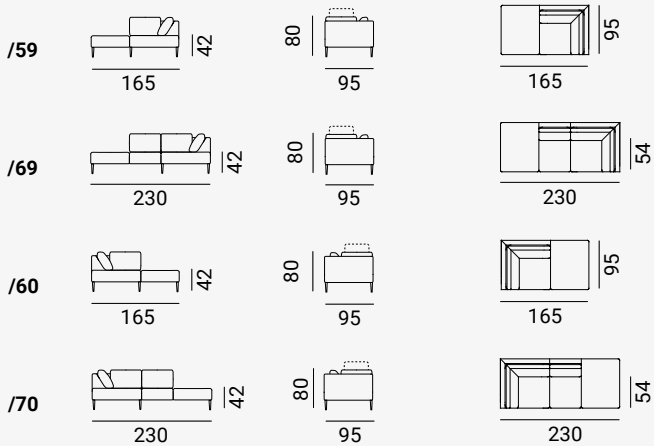

Hocker | Stool



Extra



Kissen | Cushions

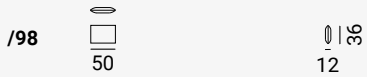

FM-441
VELAS

Sofa mit Funktion | Sofa with function

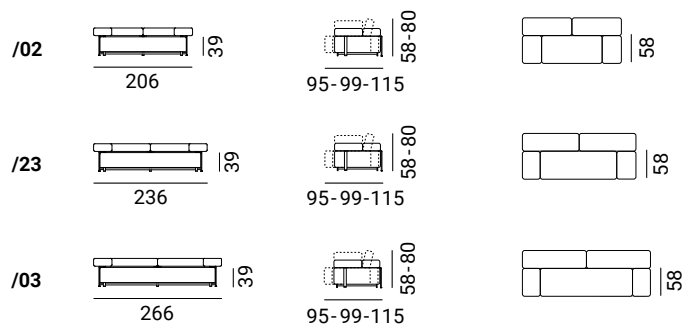

Recamieren mit Funktion | Recamieres with function

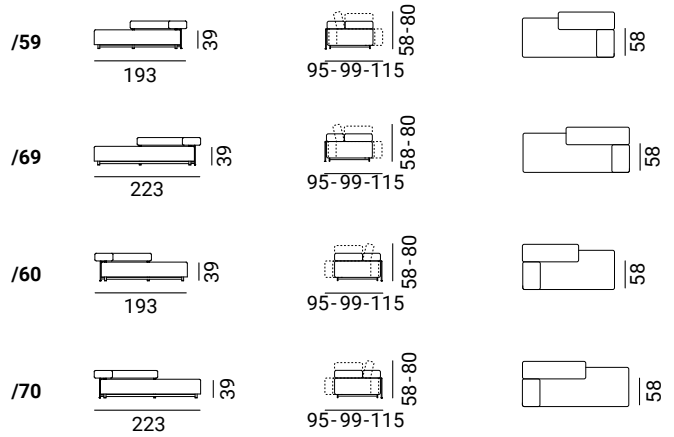

Abschlusselement links mit Funktion | End elements left functions

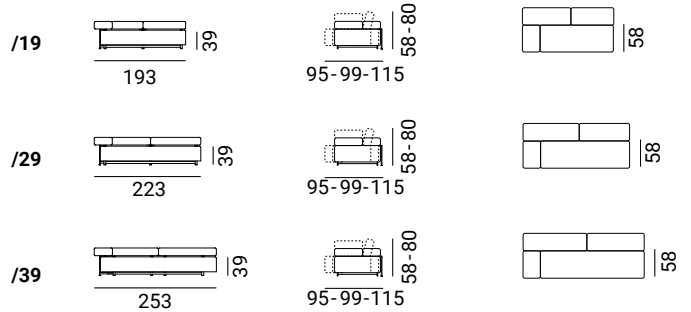

Abschlusselement rechts mit Funktion | End elements right functions

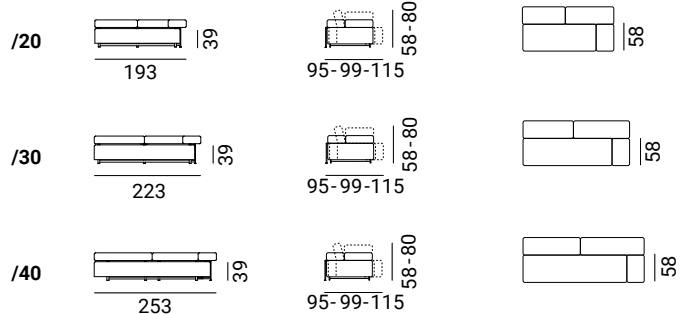

Hocker | Stool

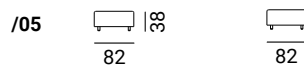

Kissen | Cushions



FM-474
EASY

Sessel | Armchair



Sofa mit Funktion | Sofa with function

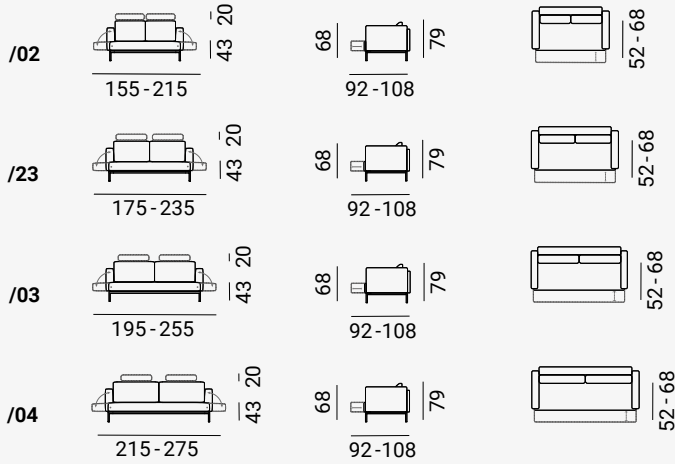

Hocker | Stool

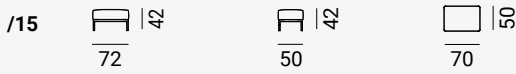

Kissen | Cushions



FM-540
JUNA

Sofa mit Funktion | Sofa with function

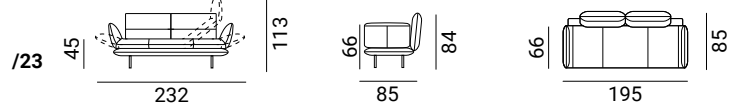

Sofa mit mit Doppel-Funktion | Sofa with double function

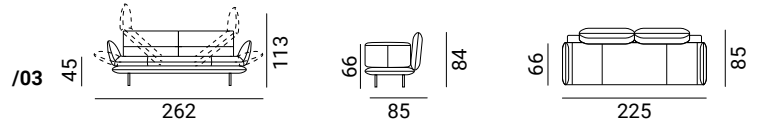

Anbauelemente mit Funktion | Additional element with function

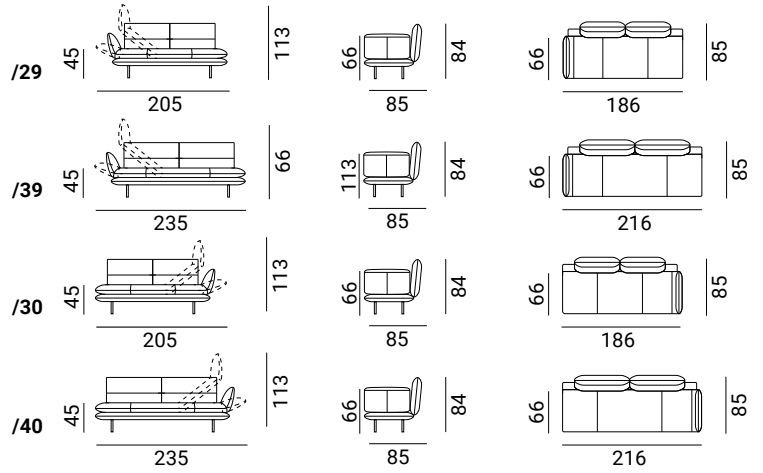

Recamieren mit Funktion | Recamieres with function

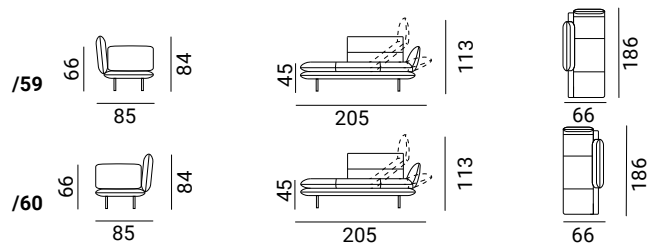

Kissen | Cushions

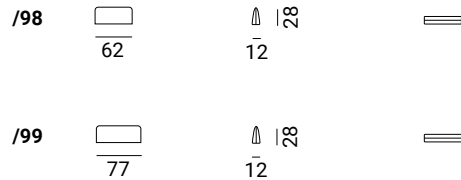

© 2021 FSM | de Sede AG
Für Fehler bei Text und Grafik
wird keine Haftung übernommen.
No liability assumed for errors
in text and graphics.



FSM | de Sede AG
Oberes Zelgli 2, CH-5313 Klingnau, T +41 56 268 01 12
info@frank-sitzmoebel.com, frank-sitzmoebel.com



frank-sitzmoebel.com